

Digital Temperature Controllers E5CN/E5CN-U

Best-selling 1/16 DIN General-purpose Temperature Controller Is Now Even Better. Easy to Set, Dependable, Complete Functionality, and 11-segment Displays.

- Faster sampling at 250 ms.
- Easy setting and monitoring with 11-segment displays.
- Easily see the status from a distance with PV display with three-color switching function.
- Setting protection indicator informs operator when protection is enabled.
- Connect to either a thermocouple or platinum resistance thermometer with the same model.
- Plug-in temperature controllers (E5CN-U) fit standard 11-pin round sockets.
- Models available with three-phase heater burnout detection and SSR fault detection.
- Voltage outputs (to drive SSRs) for both heating and cooling control. Can be used for alarms to provide three alarm outputs.
- Transfer output provided for easy output to recorders.
- Controllers now available with analog inputs.
- Manual output provided.
- Controller available with long-life relay output (*available soon*).



NEW

Features

■ Improved Functions for a Wider Range of Application

Control Analog Values, such as Pressures, Flowrates, and Levels

The new E5CN Series now also includes process controller models that accept analog inputs, allowing for control applications other than strictly temperature. These include: pressure, flowrate, level, humidity, and weight control.

Note: E5CN-□L (Models with Analog Inputs)

Faster Sampling at 250 ms

The previous sampling time of 500 ms has been reduced by half to 250 ms. This enables the new E5CN to handle applications requiring even greater response speed and accuracy.

Easy Connector to a Recorder

A transfer output now makes it easy to connect to a recorder or PLC Analog I/O Unit.

Note: E5CN-C□ (Models with Current Outputs)

Voltage Outputs (to Drive SSRs) for Both Heating and Cooling Control. Can Be Used for Alarms to Provide Three Alarm Outputs.

Voltage outputs can be used for both heating and cooling for Models with Two Control Outputs. Also, control output 2 can be set for use as an alarm output, making up to three alarm outputs possible.

Note: E5CN-□Q (Option Board)

Three-phase Heater Burnout Detection

An Option Board with Three-phase Heater Burnout and SSR Failure Detection allows two current transformers to be connected to detect both heater burnout and SSR failure at the same time. This eliminates the added cost of a separate heater burnout alarm. SSR failure detection can be used even with Models with Single-phase Heater Burnout Alarms.

Note: E5CN-□HH□ (Option Board)

■ Easy, Dependable, and Even Faster

Easy Setting with 11-segment Displays

The new E5CN features 11-segment displays to make text easier to read, eliminating the need to decode displays when trying to set parameters, or troubleshoot faults as was necessary with previous temperature controllers.

Setting Protection Indicator Informs Operator when Protection Is Enabled

A special icon on the display panel lights to let the operator know when setting protection has been set.

Multi-input Capability with One Controller

Connect to either a thermocouple or platinum resistance thermometer with the same temperature controller model. Model selection is simplified, stocks are reduced, and fewer maintenance parts are required.

Model Number Structure

■ Model Number Legend - Screw Terminal Versions

E5CN- M -500
 1 2 3 4 5

1. Output type

- R: Relay
- Q: Voltage (for driving SSR)
- C: Current
- Y: Long-life relay output (*available soon*)

2. Number of alarms

- Blank: No alarm
- 2: Two alarms

3. Option unit

- M: Option Unit can be mounted

4. Input type

- T: Thermocouple/platinum resistance thermometer (multi-input)
- L: Analog input

5. Supply voltage

- 100 - 240 VAC: AC100-240
- 24 VAC/VDC: AC/DC24

Ordering Information

■ Controllers with Temperature Inputs (Multi-input)

Stock Note: Shaded models are normally stocked.

Size	Power supply voltage	Number of alarm points	Control outputs	Model
1/16 DIN 48 × 48 × 78 (W × H × D)	100 to 240 VAC	0	Relay	E5CN-RMT-500-AC100-240
			Voltage (for driving SSR)	E5CN-QMT-500-AC100-240
			Current	E5CN-CMT-500-AC100-240
		2	Relay	E5CN-R2MT-500-AC100-240
			Voltage (for driving SSR)	E5CN-Q2MT-500-AC100-240
			Current	E5CN-C2MT-500-AC100-240
	24 VAC/DC	0	Relay	E5CN-RMT-500-AC/DC24
			Voltage (for driving SSR)	E5CN-QMT-500-AC/DC24
			Current	E5CN-CMT-500-AC/DC24
		2	Relay	E5CN-R2MT-500-AC/DC24
			Voltage (for driving SSR)	E5CN-Q2MT-500-AC/DC24
			Current	E5CN-C2MT-500-AC/DC24
			Long-life relay	E5CN-Y2MT-500-AC/DC24*

(*) Available soon.

■ Controllers with Analog Inputs

Stock Note: Shaded models are normally stocked.

Size	Power supply voltage	Number of alarm points	Control outputs	Model
1/16 DIN 48 × 48 × 78 (W × H × D)	100 to 240 VAC	0	Relay	E5CN-RML-500-AC100-240
			Voltage (for driving SSR)	E5CN-QML-500-AC100-240
			Current	E5CN-CML-500-AC100-240
		2	Relay	E5CN-R2ML-500-AC100-240
			Voltage (for driving SSR)	E5CN-Q2ML-500-AC100-240
			Current	E5CN-C2ML-500-AC100-240
	24 VAC/DC	2	Long-life relay	E5CN-Y2ML-500-AC100-240*
			Relay	E5CN-R2ML-500-AC/DC24
		Voltage (for driving SSR)	E5CN-Q2ML-500-AC/DC24	
		Current	E5CN-C2ML-500-AC/DC24	

(*) Available soon.

Option Units

The E5CN provides optional functionality when one of the following Option Units is mounted.

Stock Note: Shaded models are normally stocked.

Functions	Model
Communications + Heater burnout + SSR failure detection	E53-CNH03N
Communications	E53-CN03N
Communications + Heater burnout + SSR failure detection + Event inputs	E53-CNHBN
Event inputs	E53-CNBN
Communications + 3-phase heater burnout + SSR failure detection	E53-CNHH03N
Communications + Control output 2 (voltage output)	E53-CNQ03N
Communications + Heater burnout + SSR failure detection + Control output 2 (voltage output)	E53-CNQHN

Note: Option Units cannot be used for E5CN-U Plug-in models. These Option Units can be used for the new E5CN models only.

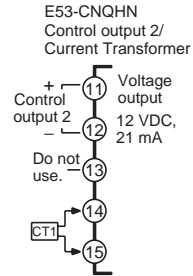
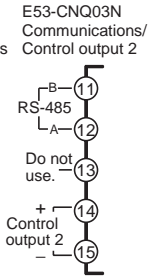
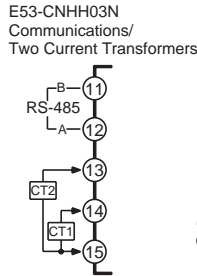
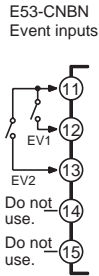
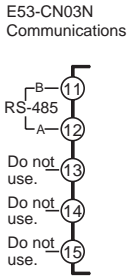
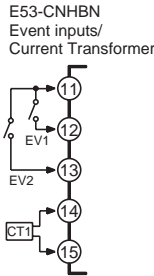
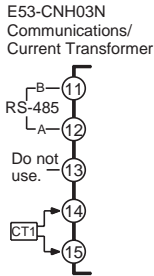

Model Number Structure

Model Number Legend - Plug-in type Controllers

E5CN-□□□□U
1 2 3 4 5

1. Output type

R: Relay
Q: Voltage

2. Number of alarms

Blank: No alarm
1: One alarm
2: Two alarms

3. Input type

T: Thermocouple/platinum resistance thermometer (multi-input)

4. Plug-in type

U: Plug-in type

5. Supply voltage

100-240 VAC: AC100-240
24 VAC/DC: AC/DC24

Ordering Information

Plug-in Controllers with Temperature Inputs (Multi-input)

Stock Note: Shaded models are normally stocked.

Size	Power supply voltage	Number of alarm points	Control outputs	Model
1/16 DIN 48 × 48 × 84.7 (W × H × D)	100 to 240 VAC	0	Relay	E5CN-RTU-AC100-240
			Voltage (for driving SSR)	E5CN-QTU-AC100-240
		1	Relay	E5CN-R1TU-AC100-240
			Voltage (for driving SSR)	E5CN-Q1TU-AC100-240
		2	Relay	E5CN-R2TU-AC100-240
			Voltage (for driving SSR)	E5CN-Q2TU-AC100-240
	24 VAC/DC	0	Relay	E5CN-RTU-AC/DC24
			Voltage (for driving SSR)	E5CN-QTU-AC/DC24
		1	Relay	E5CN-R1TU-AC/DC24
			Voltage (for driving SSR)	E5CN-Q1TU-AC/DC24
		2	Relay	E5CN-R2TU-AC/DC24
			Voltage (for driving SSR)	E5CN-Q2TU-AC/DC24

Note: Option Units (E53-CN□□N) cannot be used for Plug-in models.

Accessories (Order Separately)

Stock Note: Shaded models are normally stocked.

Terminal Cover

Connectable models	Terminal type
Model	E53-COV10

Current Transformers (CTs)

Model	E54-CT1	E54-CT3
Current load	50 A	120 A
Hole diameter	5.8 dia.	12.0 dia.

Note: Use these for heater burnout alarm output. With option unit E53-CNH03N, order two current transformers.

Mounting Adapter

Connectable models	Terminal type
Function	Converts 72 x 72 mm panel cutout to 48 x 48 mm
Model	Y92F-45

Note: Use this Adapter when the panel has been previously prepared for the E5B□.

Sockets (for Plug-in Connector Models)

Model	P2CF-11	P2CF-11-E	P3GA-11	Y92A-48G
Type	Front-connecting Socket Bottom surface or track mounting, top screw terminals	Front-connecting Socket with Finger Protection Bottom surface or track mounting, top screw terminals	Back-connecting socket Back mounting, for use with Y92F-30 mounting adapter supplied, bottom screw terminals	Terminal Cover for Finger Protection For P3GA-11

Specifications

■ Ratings

Item	Power supply voltage	100 to 240 VAC, 50/60 Hz	24 VAC, 50/60 Hz or 24 VDC
Operating voltage range		85% to 110% of rated supply voltage	
Power consumption	E5CN	7.5 VA max. (E5CN-R2T: 3.0 VA at 100 VAC)	5 VA/3 W max. (E5CN-R2T: 2.7 VA at 24 VAC)
	E5CN-U	6 VA max.	3 VA/2 W max.
Sensor input		Models with temperature inputs Thermocouple: K, J, T, E, L, U, N, R, S, or B Platinum resistance thermometer: Pt100 or JPt100 Infrared temperature sensor: 10 to 70°C, 60 to 120°C, 115 to 165°C, or 160 to 260°C Voltage input: 0 to 50 mV Models with analog inputs Current input: 4 to 20 mA or 0 to 20 mA Voltage input: 1 to 5 V, 0 to 5 V, or 0 to 10 V	
Input impedance		Current input: 150 Ω, Voltage input: 1 MΩ (Use a 1:1 connection when connecting the ES2-HB.)	
Control output	Relay output	E5CN	SPST-NO, 250 VAC, 3 A (resistive load), electrical life: 100,000 operations, minimum applicable load: 5 V, 10 mA
		E5CN-U	SPDT, 250 VAC, 3 A (resistive load), electrical life: 100,000 operations, minimum applicable load: 5 V, 10 mA
	Voltage output	E5CN E5CN-U	Output voltage: 12 VDC ±15% (PNP), max. load current: 21 mA, with short-circuit protection circuit
	Current output	E5CN	4 to 20 mA DC/0 to 20 mA DC, load: 600 Ω max., resolution: approx. 2,700
	Long-life relay output	E5CN	SPST-NO, 250 VAC, 3 A (resistive load), electrical life: 1,000,000 operations, minimum applicable load: 5 V, 100 mA (Do not connect a DC load.)
Alarm output		SPST-NO, 250 VAC, 1 A (resistive load), electrical life: 100,000 operations, minimum applicable load: 1 V, 1 mA	
Event input	Contact input	ON: 1 kΩ max., OFF: 100 kΩ min.	
	Non-contact input	ON: Residual voltage: 1.5 V max., OFF: Leakage current: 0.1 mA max.	
		Outflow current: Approx. 7 mA per point	
Control method		ON/OFF control or 2-PID control (with auto-tuning)	
Setting method		Digital setting using front panel keys	
Indication method		11-segment digital display and individual indicators (7-segment displays also possible) Character height: PV: 11 mm, SV: 6.5 mm	
Other functions		Manual output, heating/cooling control, transfer output (on some models), loop break alarm, multi SP, MV limiter, input digital filter, self-tuning, temperature input shift, run/stop, protection functions, etc.	
Ambient operating temperature		-10 to 55°C (with no icing or condensation), for 3-year warranty: -10 to 50°C	
Ambient operating humidity		25% to 85%	
Storage temperature		-25 to 65°C (with no icing or condensation)	

Input Ranges

Temperature Controller Models (Multi-inputs)

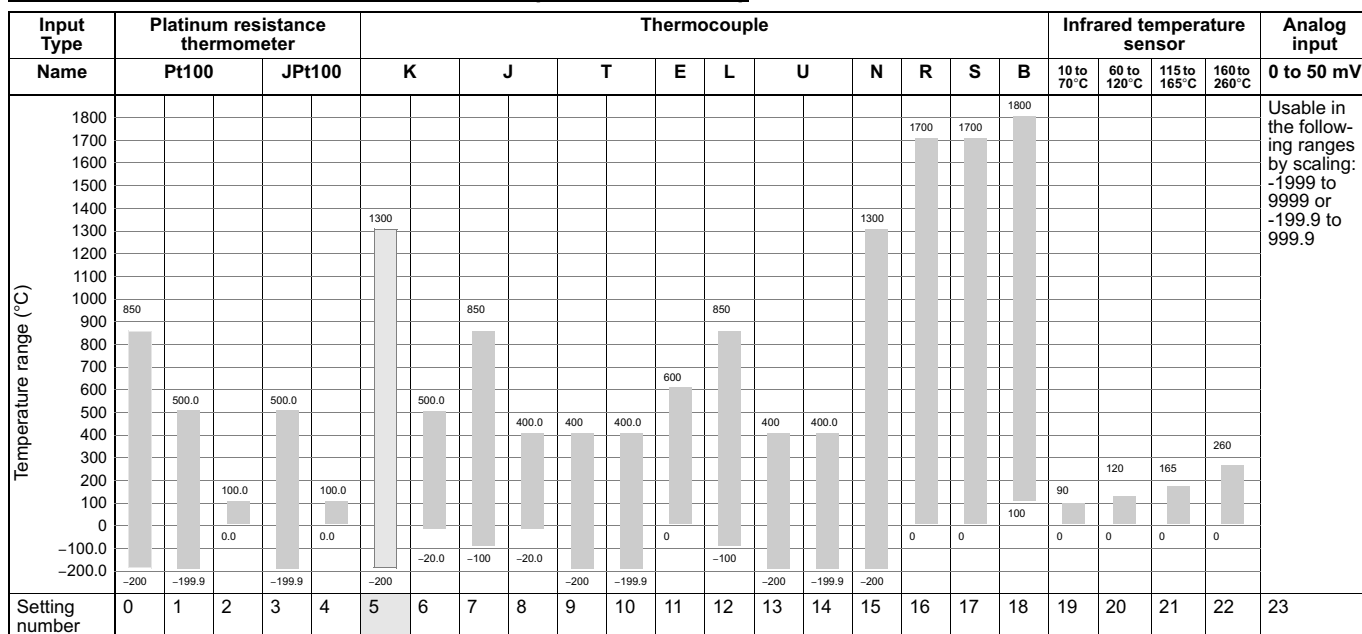

The applicable standards for the input types are as follows:

K, J, T, E, N, R, S, B: IEC584-1

L: Fe-CuNi, DIN 43710-1985

U: Cu-CuNi, DIN 43710-1985
Pt100: IEC 751

Note: Shaded setting number is the default range.











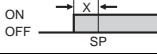
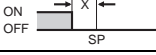
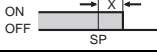
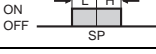

Models with Analog Inputs

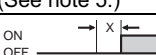
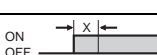
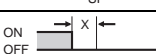
Input Type	Current		Voltage		
	Input specification	4 to 20mA	0 to 20 mA	1 to 5 V	0 to 5 V
Setting range	Usable in the following ranges by scaling: -1999 to 9999, -199.9 to 999.9, -19.99 to 99.99 or -1.999 to 9.999				
Setting number	0	1	2	3	4

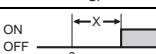
Note: Shaded setting number is the default range.

Alarm Types

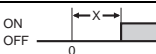
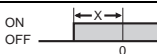
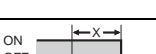
Select alarm types out of the 12 alarm types listed in the following table.

Set value	Alarm type	Alarm output operation	
		When X is positive	When X is negative
0	Alarm function OFF	Output OFF	
1 (See note 1.)	Upper- and lower-limit	ON OFF 	(See note 2.)
2	Upper limit	ON OFF 	ON OFF 
3	Lower limit	ON OFF 	ON OFF 
4 (See note 1.)	Upper- and lower-limit range	ON OFF 	(See note 3.)
5 (See note 1.)	Upper- and lower-limit with standby sequence	ON OFF 	(See note 4.)
6	Upper-limit with standby sequence	ON OFF 	ON OFF 
7	Lower-limit with standby sequence	ON OFF 	ON OFF 
8	Absolute-value upper-limit	ON OFF 	ON OFF 
9	Absolute-value lower-limit	ON OFF 	ON OFF 
10	Absolute-value upper-limit with standby sequence	ON OFF 	ON OFF 
11	Absolute-value lower-limit with standby sequence	ON OFF 	ON OFF 
12 (See note 6.)	Loop Break Alarm (for alarm 1 only)	---	

Note: 1. With set values 1, 4 and 5, the upper and lower limit values can be set independently for each alarm type, and are expressed as "L" and "H."

2. Set value: 1, Upper- and lower-limit alarm

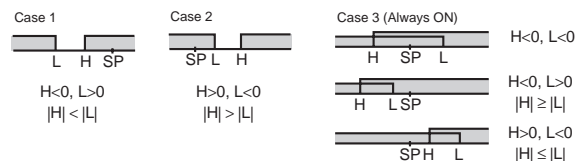

3. Set value: 4, Upper- and lower-limit range

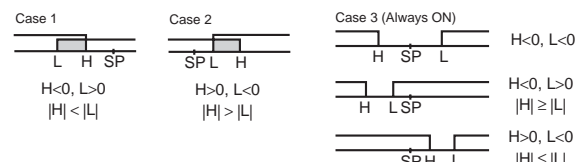

4. Set value: 5, Upper- and lower-limit with standby sequence For Upper- and Lower-Limit Alarm Described Above

- Case 1 and 2
Always OFF when the upper-limit and lower-limit hysteresis overlaps.
- Case 3: Always OFF

5. Set value: 5, Upper- and lower-limit with standby sequence Always OFF when the upper-limit and lower-limit hysteresis overlaps.

6. Set value: 12, Loop Break Alarm can be set only for alarm 1.

Set the alarm types for alarms 1 to 3 independently in the initial setting level. The default setting is 2 (upper limit).

■ Controller Characteristics

Indication accuracy	Thermocouple: (See note 1.) E5CN: ($\pm 0.5\%$ of indicated value or $\pm 1^\circ\text{C}$, whichever is greater) ± 1 digit max. E5CN-U: ($\pm 1\%$ of indicated value or $\pm 2^\circ\text{C}$, whichever is greater) ± 1 digit max. Platinum resistance thermometer: ($\pm 0.5\%$ of indicated value or $\pm 1^\circ\text{C}$, whichever is greater) ± 1 digit max. Analog input: $\pm 0.5\%$ FS ± 1 digit max. CT input: $\pm 5\%$ FS ± 1 digit max.	
Hysteresis	Models with thermocouple/platinum resistance thermometer (multi-input) input: 0.1 to 999.9 EU (in units of 0.1 EU) Models with analog input: 0.01 to 99.99% FS (in units of 0.01% FS)	
Proportional band (P)	Models with thermocouple/platinum resistance thermometer (multi-input) input: 0.1 to 999.9 EU (in units of 0.1 EU) Models with analog input: 0.1 to 999.9% FS (in units of 0.1% FS)	
Integral time (I)	0 to 3999 s (in units of 1 s)	
Derivative time (D)	0 to 3999 s (in units of 1 s) (See note 3.)	
Control period	0.5, 1 to 99 s (in units of 1 s)	
Manual reset value	0.0 to 100.0% (in units of 0.1%)	
Alarm setting range	-1999 to 9999 (decimal point position depends on input type)	
Sampling period	250 ms	
Affect of signal source resistance	Thermocouple: $0.1^\circ\text{C}/\Omega$ max. (100 Ω max.) (See note 4.) Platinum resistance thermometer: $0.4^\circ\text{C}/\Omega$ max. (10 Ω max.)	
Insulation resistance	20 M Ω min. (at 500 VDC)	
Dielectric strength	2,000 VAC, 50 or 60 Hz for 1 min (between terminals with different charge)	
Vibration resistance	Malfunction	10 to 55 Hz, 20 m/s ² for 10 min each in X, Y, and Z directions
	Destruction	10 to 55 Hz, 0.75-mm single amplitude for 2 hrs each in X, Y, and Z directions
Shock resistance	Malfunction	100 m/s ² min., 3 times each in X, Y, and Z directions
	Destruction	300 m/s ² min., 3 times each in X, Y, and Z directions
Weight	E5CN	Controller: Approx. 150 g, Mounting Bracket: Approx. 10 g
	E5CN-U	Controller: Approx. 110 g, Mounting Bracket: Approx. 10 g
Degree of protection	E5CN	Front panel: NEMA4X for indoor use (equivalent to IP66) Rear case: IP20, Terminal section: IP00
	E5CN-U	Front panel: Equivalent to IP50, rear case: IP20, terminals: IP00
Memory protection	Non-volatile memory (number of writes: 1,000,000 operations)	

- Note:**
- The indication of K thermocouples in the -200 to 1300°C range, T and N thermocouples at a temperature of -100°C max., and U and L thermocouples at any temperature is $\pm 2^\circ\text{C} \pm 1$ digit maximum. The indication accuracy of the B thermocouple at a temperature of 400°C max. is not specified. The indication accuracy of the R and S thermocouples at a temperature of 200°C max. is $\pm 3^\circ\text{C} \pm 1$ digit max.
 - "EU" stands for Engineering Unit and is used as the unit after scaling. For a temperature sensor, the EU is °C or °F.
 - When robust tuning (RT) is ON, the differential time is 0.0 to 999.9 (in units of 0.1 s).
 - B, R, and S sensors: $0.2^\circ\text{C}/\Omega$ max. (100 Ω max.)

■ Communications Specifications

Transmission line connection method	RS-485 multipoint
Communications	RS-485 (two-wire, half duplex)
Synchronization method	Start-stop synchronization
Baud rate	1200, 2400, 4800, 9600, 19200, or 38400 bps
Transmission code	ASCII
Data bit length	7 or 8 bits
Stop bit length	1 or 2 bits
Error detection	Vertical parity (none, even, odd) Frame check sequence (FCS) with SYSWAY Block check character (BCC) with CompoWay/F or CRC-16 Modbus
Flow control	None
Interface	RS-485
Retry function	None
Communications buffer	40 bytes
Communications response wait time	0 to 99 ms Default: 20 ms

Note: The baud rate, data bit length, stop bit length, and vertical parity can be individually set using the Communications Setting Level.

■ Current Transformer Specifications

Ratings

Current load	E54-CT1: 50 A E54-CT3: 100 A
Dielectric strength	1,000 VAC for 1 min
Vibration resistance	50 Hz, 98 m/s ²
Weight	E54-CT1: Approx. 11.5 g, E54-CT3: Approx. 50 g
Accessories (E54-CT3 only)	Armatures (2) Plugs (2)

■ Heater Burnout Alarms and SSR Failure Detection Alarms

(E5CN Models with Heater Burnout and SSR Failure Detection Alarms)

Maximum heater current	50 A AC
Input current indication accuracy	±5% FS ±1 digit max.
Heater burnout alarm setting range	0.1 to 49.9 A (in units of 0.1 A) 0.0 A: Heater burnout/SSR failure alarm output turned OFF. 50.0 A: Heater burnout/SSR failure alarm output turned ON. Minimum detection ON time: 190 ms (See note 1.)
SSR failure detection alarm setting range	0.1 to 49.9 A (in units of 0.1 A) 0.0 A: Heater burnout/SSR failure alarm output turned ON. 50.0 A: Heater burnout/SSR failure alarm output turned OFF. Minimum detection OFF time: 190 ms (See note 2.)

- Note: 1.** If the ON time of control output 1 is less than 190 ms, heater burnout detection and the heater current will not be measured.
- 2.** If the OFF time of control output 1 is less than 190 ms, SSR failure detection and the heater current will not be measured.

■ Electrical Life Expectancy Curve for Relays (Reference Values)

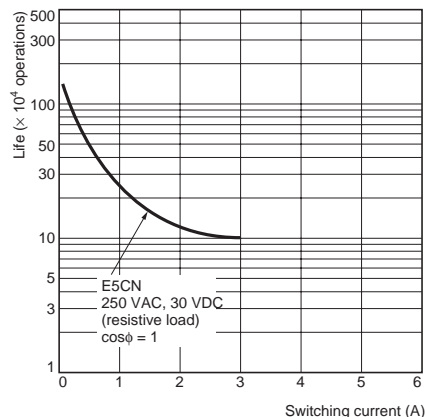

Note: Do not connect a DC load to a Controller with a Long-life Relay Output.

External Connections

- A voltage output (control output) is not electrically insulated from the internal circuits. When using a grounding thermocouple, do not connect any of the control output terminals to ground. If the control output terminals are connected to ground, errors will occur in the measured temperature values as a result of leakage current.
- Standard insulation is applied between any of the following: power supply terminals, input terminals, output terminals, and communications terminals (for models with communications). If reinforced insulation is required, provide additional insulation, such as spacial distance or material insulation, as defined by IEC 60664 suitable for the maximum operating voltage.
- The input power supply depends on the power supply specifications of the Controller and is either 100 to 240 VAC or 24 VAC/VDC (no polarity).

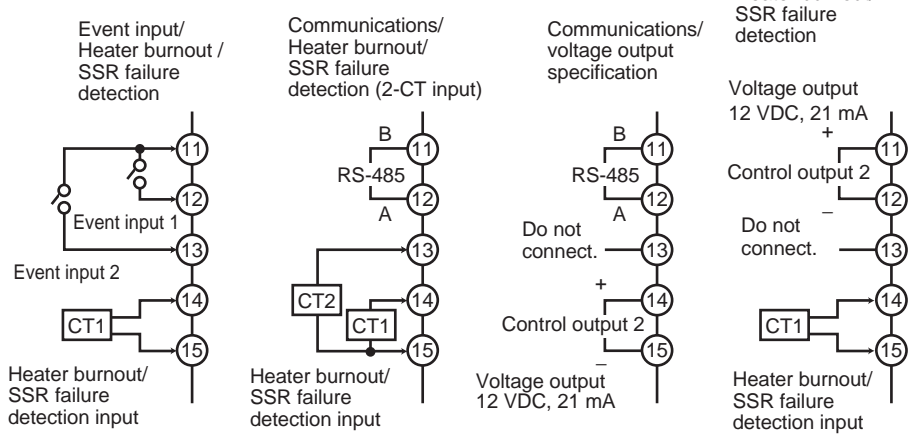
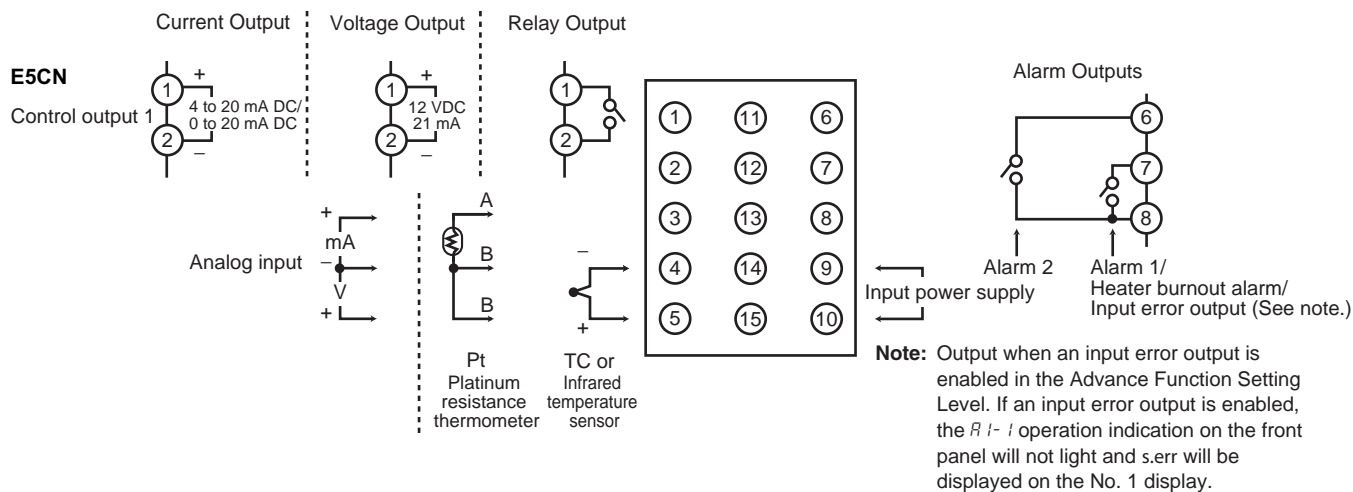

Terminals 11 to 15 do not exist on models without an Option Unit (heater burnout detection, control output 2, event inputs, or communications). Terminal applications depend on the model of the Option Unit.

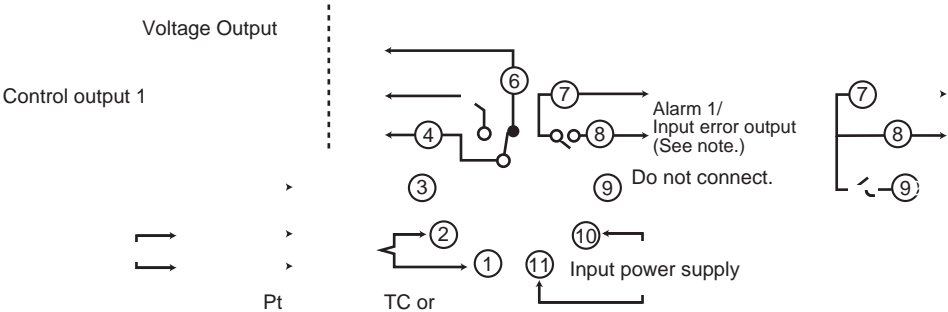

Nomenclature

E5CN
E5CN-U

The front panel is the same for the E5CN and E5CN-U.

Dimensions

Unit: mm

■ Standard Models

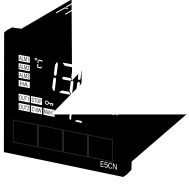

■ Accessories

Current Transformers (Sold Separately)

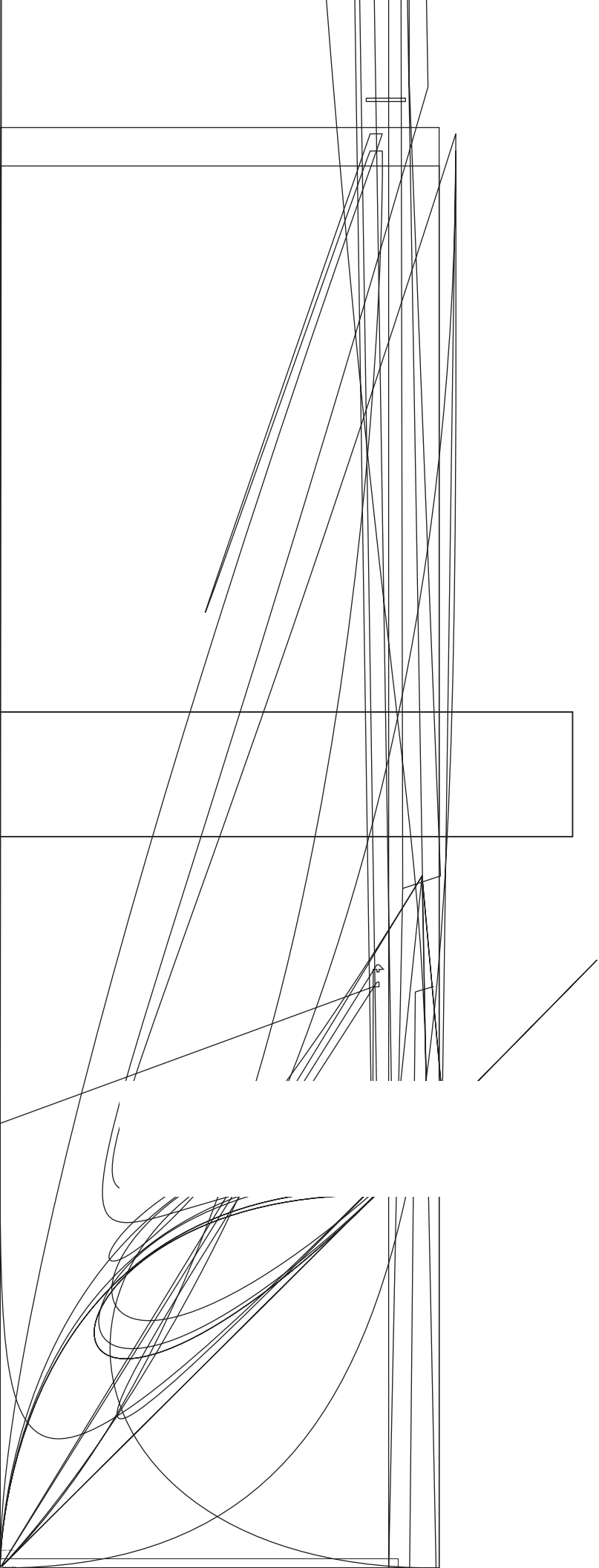

Parameters

Some parameters are not displayed depending on the model of the Controller and parameter settings. For details, refer to the E5CN/E5CN-U Temperature Controller User's Manual (Cat. No. H129)

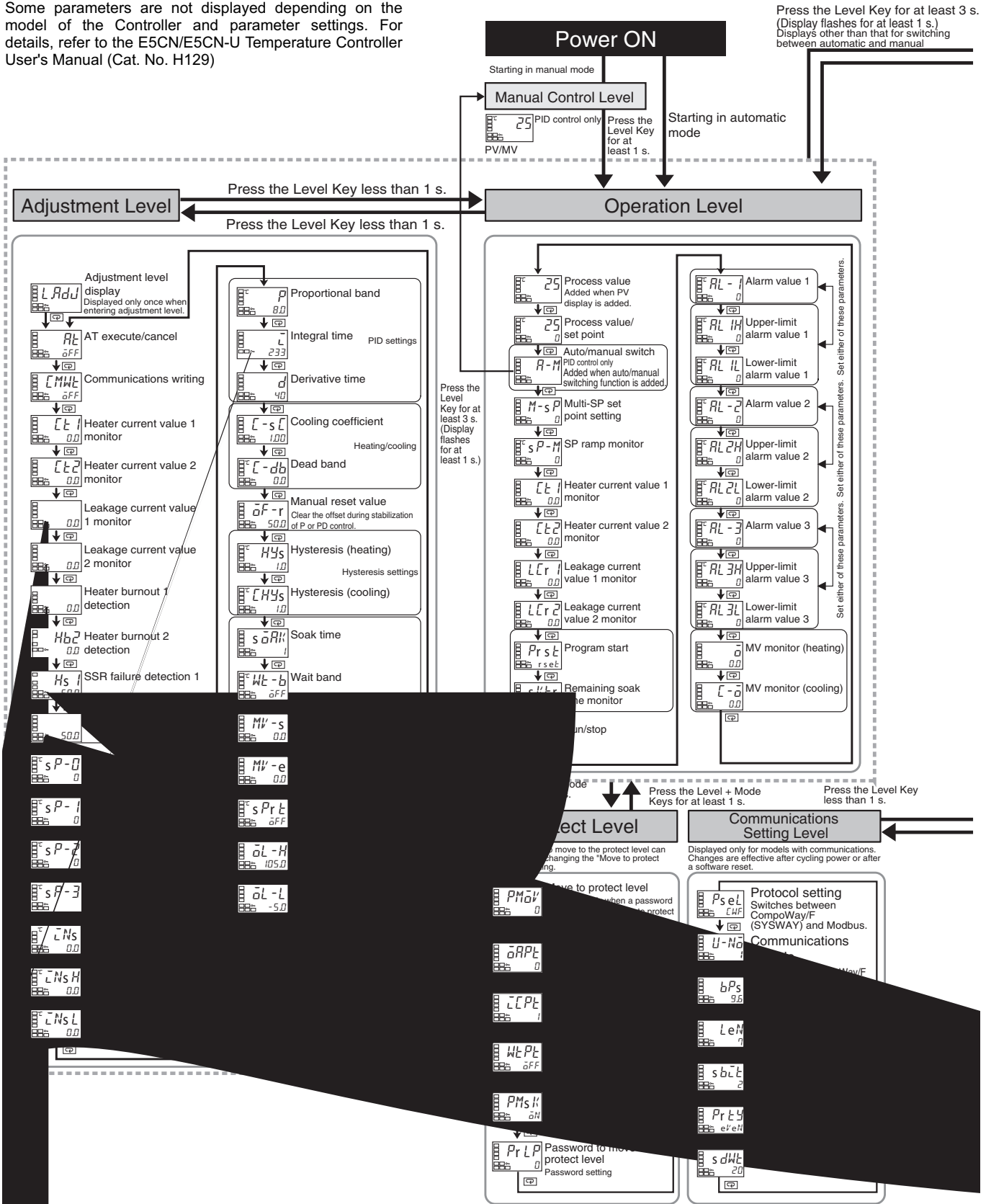

Press the Level Key for at least 1 s.

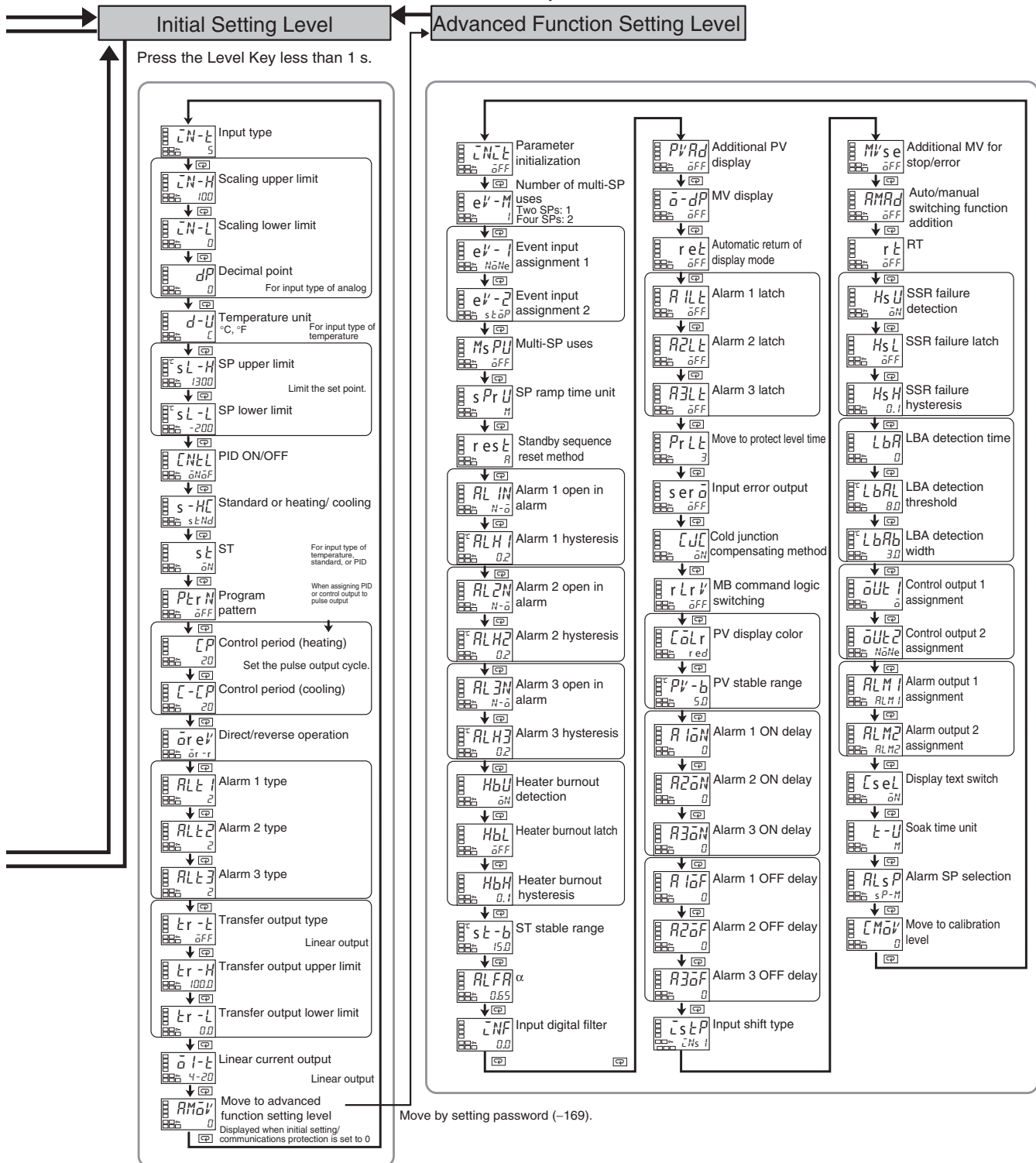

Note: LBA = Loop Break Alarm.

Improvements to E5CN Functionality

Changes

Model numbers have been changed to allow for multi-input specifications.

Before Change

E5CN-□□□TC (models for thermocouples)
E5CN-□□□P (models for platinum resistance thermometers)



After Change

E5CN-□□□T
(Models that support both thermocouples and platinum resistance thermometers)

Precautions in Replacing Previous Controllers

- The input type setting numbers have changed to allow for multi-input specifications. (The default setting is for a K sensor between -200 and 1,300°C.)
- Previous E5CN Controllers cannot be removed from the case for replacement with new models. Replace the case at the same time.
- The previous ThermoTools cannot be used with the new Controller models. Use the ThermoTools scheduled for marketing from July 2004.
- The front panel thickness that extends when the Controller is mounted to a panel has been reduced from 9 to 6 mm.

Note: Items That Have Not Been Changed

- Panel cutout dimensions
- Panel interior dimensions for panel mounting
- Wiring terminal sizes
- Wiring terminal arrangement
- Parameter setting procedure

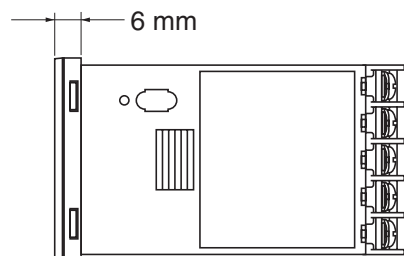

The following items do not change in comparison to the previous E5CN models: Panel cutout, Internal panel dimensions for panel mounting, wiring screw sizes, wiring terminal arrangement, and parameter setting methods.

Improved Functions

The previous and new models can be easily differentiated by looking at the front panel. The OMRON logo is in a different position.

Item	Previous models (OMRON logo: lower left)	Improved models (OMRON logo: upper left)
Front panel		

Basically, the Controllers are upwardly compatible. The terminal arrangement, terminal sizes, and depth for panel mounting have not been changed. Changes are listed in the following tables. For details, refer to the E5CN/E5CN-U Temperature Controller User's Manual (Cat. No. H129) and to the E5CN Temperature Controller Communications User's Manual (Cat. No. H130).

■ Specifications

Ratings

Item		Previous models	Improved models
Power consumption	E5CN	7 VA (100 to 240 VAC, 50/60 Hz) 4 VA/3 W (24 VAC, 50/60 Hz or 24 VDC)	7.5 VA (100 to 240 VAC, 50/60 Hz) 4 VA/3 W (24 VAC, 50/60 Hz or 24 VDC)
	E5CN-U	6 VA (100 to 240 VAC, 50/60 Hz) 3 VA/2 W (24 VAC, 50/60 Hz or 24 VDC)	6 VA (100 to 240 VAC, 50/60 Hz) 3 VA/2 W (24 VAC, 50/60 Hz or 24 VDC)
Sensor input	E5CN-□□TC	Thermocouple: K, J, T, E, L, U, N, R, S, or B Infrared temperature sensor: 10 to 70°C, 60 to 120°C or 115 to 165°C (160 to 260°C) Voltage input: 0 to 50 mV	E5CN-□□T (Multi-input models) Thermocouple: K, J, T, E, L, U, N, R, S, or B Infrared temperature sensor: 10 to 70°C, 60 to 120°C or 115 to 165°C (160 to 260°C) Voltage input: 0 to 50 mV Platinum resistance thermometer: Pt100 or JPt100
	E5CN-□□P	Platinum resistance thermometer: Pt100 or JPt100	
	(No models with analog inputs)		E5CN-□□L (Models with analog inputs added.) Current input: 4 to 20 mA or 0 to 20 mA Voltage input: 1 to 5 V, 0 to 5 V, or 0 to 10 V
Control output	Relay	E5CN-R□□	E5CN-R□□
		SPST-NO, 250 VAC, 3 A (resistive load) Electrical life: 100,000 operations min.	SPST-NO, 250 VAC, 3 A (resistive load) Electrical life: 100,000 operations min.
	---	E5CN-Y□□ (Added models with long-life relay outputs.) (To be available soon) SPST-NO, 250 VAC, 3 A (resistive load) Electrical life: 1,000,000 operations min. DC loads cannot be connected.	
Voltage	E5CN-Q□□	E5CN-Q□□	
Current	E5CN-C□□	E5CN-C□□	
Control output 2	Voltage	(No models with two control outputs)	(Option Unit) 12 VDC ±15% (PNP) Max. load current: 21 mA With short-circuit protection
Display method		7-segment digital display and single-LED indicators Character height: PV: 9.9 mm, SV: 6.4 mm	11-segment digital display and single-LED indicator (Improved visibility) (A 7-segment digital display also possible.) Character height: PV: 11.0 mm, SV: 6.5 mm
Transfer output		(No models with transfer outputs)	E5CN-C□□ (current output) Allocated to current output 4 to 20 mA DC or 0 to 20 mA DC Load: 600 Ω max. Resolution: Approx. 2,700

Other Functions

Item	Previous models	Improved models
Display	---	Parameter mask function (provided with setting software)
	PV display switch between 2 colors (red/green)	PV display switch between 3 colors (red/orange/green)
	---	Display character switch (7-segment/11-segment)
Input	Temperature input shift (1-point shift for temperature input, 2-point shift for no-contact sensor input)	Temperature input shift (2-point shift also possible for temperature input)
Output	---	Manual outputs
	---	MV at stop
	---	MV at PV error
	---	Loop break alarm
Control	Control period: 1 to 99 s	Control period: 0.5 or 1 to 99 s
	---	Robust tuning
Alarm	---	Alarm delays
	---	Alarm SP selection (selection of alarm operation of SP indicator)
Other	---	Simple programming function
	---	Password to move to protect level
	---	Setting software port

Characteristics

Item	Previous models	Improved models
Sampling period	500 ms	250 ms

Communications Specifications

Item	Previous models	Improved models
Communications protocols	CompoWay/F (SYSWAY)	CompoWay/F (SYSWAY), Modbus
Baud rate	1200, 2400, 4800, 9600, 19200 bps	1200, 2400, 4800, 9600, 19200, 38400 bps

Heater Burnout/SSR Failure Detection Characteristics

Item	Previous models	Improved models
Maximum heater current	Option Units Single-phase 50 A VAC	Option Units Single-phase 50 A AC
	---	Option Units (two CT inputs) Three-phase 50 A AC
SSR failure detection	---	SSR failure detection

Precautions

CAUTION

Do not touch any of the terminals while the power is being supplied. Doing so may occasionally result in minor electric shock.



Do not allow pieces of metal or wire cuttings to get inside the Temperature Controller. Failure to do so may occasionally result in minor electric shock, fire, or damage to equipment.



Do not use the Temperature Controller in locations subject to flammable or explosive gas. Doing so may occasionally result in minor injury due to explosion.



Do not attempt to disassemble, modify, or repair the Temperature Controller or touch any internal components. Doing so may occasionally result in minor electric shock, fire, or damage to equipment.



Caution: Danger of Electric Shock

a) This Temperature Controller is UL-listed as an open-type process controller. Use it in a control panel structure so that fire will not leave the panel.

b) When using two or more cutoff switches, turn OFF all switches so that no power is supplied to the Temperature Controller before maintenance or inspections.

c) Signal inputs are SELV restricted circuits. (See note 1.)

d) Caution: To reduce the danger of fire or electric shock, do not internally connect the outputs of different class 2 circuits. (See note 2.)



If the output relay is used beyond its life expectancy, its contacts may occasionally become fused or burned. Always consider the actual application conditions and be sure to use the output relay within its rated load and electrical life expectancy. The life expectancy of the output relay varies considerably according to its switching capacity and operating conditions.



Fire may occasionally occur if terminal screws become loose. Tighten the terminal screws using a torque between 0.74 and 0.90 N·m.



Make settings for the Temperature Controller that are suitable for the controlled system. Failure to do so may result in unexpected operation occasionally resulting in damage to equipment or personal injury.



Warning: To reduce the danger of electric shock or fire, use the Temperature Controller in an controlled environment relatively free from polluting materials.



Take appropriate safety measures, such as installing a separate monitoring system, to ensure safe operation in the event of a malfunction of the Temperature Controller. Loss of operation control or alarm outputs due to malfunction may occasionally result in physical damage to the controlled system or equipment.



- Note:**
1. An SELV circuit is one separated from the power supply with double insulation or reinforced insulation, that does not exceed 30 V r.m.s. and 42.4 V peak or 60 VDC.
 2. A class 2 power supply is one tested and certified by UL as have the current and voltage of the secondary output restricted to specific levels.

Precautions for Safe Use

1. Do not use the Temperature Controller in the following locations.
 - Locations exposed to radiated heat from heating devices
 - Locations subject to exposure to water or oil
 - Locations subject to direct sunlight
 - Locations subject to dust or corrosive gas (especially sulfide gas or ammonia gas)
 - Locations subject to severe temperature changes
 - Locations subject to icing or condensation
 - Locations subject vibration or strong shock
2. Use and store the Temperature Controller within the rated ambient temperature and humidity. When two or more Temperature Controllers are mounted horizontally close to each other or vertically next to one another, the internal temperature will increase due to heat radiated by the Temperature Controllers and the service life will decrease. In such a case, use forced cooling by fans or other means of air ventilation to cool down the Temperature Controllers.
3. Allow enough space around the Temperature Controller to ensure proper heat dissipation. Do not block the ventilating holes.
4. Be sure to wire terminals properly using the correct polarity.
5. Use crimp terminals with the specified dimensions (M3.5, width 7.2 mm max.).
Use wires of a thickness of AWG24 (0.205 mm²) to AWG14 (2.081 mm²). The exposed current-carrying part to be inserted into terminals must be 5 to 6 mm.
6. Do not connect anything to unused terminals.
7. Allow as much space as possible between the Controller and devices that generate powerful high frequencies (high-frequency welders, high-frequency sewing machines, etc.) or surge. Keep the wiring for the Temperature Controller's terminal block away from power cables carry high voltages or large currents. Also, do not wire power lines together with or parallel to Temperature Controller wiring.
8. Use the Temperature Controller within a power supply voltage and load that meet all specifications and ratings.
9. Set up the power supply so that the voltage will reach the rated voltage within 2 seconds after turning ON.
10. Allow at least 30 minutes for the Temperature Controller to warm up.
11. When using self-tuning, turn ON power for the load (e.g., heater) at the same time as or before supplying power to the Temperature Controller.
12. Install the appropriate switches and circuit breakers and label them accordingly so that power can be turned OFF in an emergency by the person operating the Temperature Controller.
13. If you remove the Controller from its case, do not touch or apply shock to the electronic parts inside. When placing the Controller back in the case, make sure that electronic parts do not come in contact with the case.
14. Use alcohol to clean the Temperature Controller. Do not use thinner or other solvent-based substances.
15. It will require 2 seconds for the outputs from the Temperature Controller to stabilize after turning ON the power supply. Design the system (e.g., the control panel) to allow for this time.
16. Outputs will turn OFF depending on the mode when switching to the initial setting mode. Confirm system safety before switching the mode.

Precautions for Correct Use

Service Life

- Use the Temperature Controller within the following temperature and humidity ranges:
 Temperature: -10 to 55°C (with no icing or condensation)
 Humidity: 25% to 85%
 If the Controller is installed inside a control board, the ambient temperature must be kept to under 55°C, including the temperature around the Controller.
- The service life of electronic devices like Temperature Controllers is determined not only by the number of times the relay is switched but also by the service life of internal electronic components. Component service life is affected by the ambient temperature: the higher the temperature, the shorter the service life and, the lower the temperature, the longer the service life. Therefore, the service life can be extended by lowering the temperature of the Temperature Controller.
- When two or more Temperature Controllers are mounted horizontally close to each other or vertically next to one another, the internal temperature will increase due to heat radiated by the Temperature Controllers and the service life will decrease. In such a case, use forced cooling by fans or other means of air ventilation to cool down the Temperature Controllers. When providing forced cooling, however, be careful not to cool down the terminals sections alone to avoid measurement errors.

Measurement Accuracy

- When extending or connecting the thermocouple lead wire, be sure to use compensating wires that match the thermocouple type.
- When extending or connecting the lead wire of the platinum resistance thermometer, be sure to use wires that have low resistance and keep the resistance of the three lead wires the same.
- Mount the Temperature Controller so that it is horizontally level.
- If the measurement accuracy is low, check to see if input shift has been set correctly.

Waterproofing

The degree of protection is as shown below. Sections without any specification on their degree of protection or those with IP□0 are not waterproof.

Front panel: NEMA4X for indoor use (equivalent to IP66)
 Rear case: IP20, Terminal section: IP00
 (E5CN-U: Front panel: Equivalent to IP50, rear case: IP20, terminals: IP00)

Operating Precautions

- It takes approximately two seconds for the outputs to turn ON from after the power supply is turned ON. Due consideration must be given to this time when incorporating Temperature Controllers in a sequence circuit.
- When using self-tuning, turn ON power for the load (e.g., heater) at the same time as or before supplying power to the Temperature Controller. If power is turned ON for the Temperature Controller before turning ON power for the load, self-tuning will not be performed properly and optimum control will not be achieved.
- When starting operation after the Temperature Controller has warmed up, turn OFF the power and then turn it ON again at the same time as turning ON power for the load. (Instead of turning the Temperature Controller OFF and ON again, switching from STOP mode to RUN mode can also be used.)
- Avoid using the Controller in places near a radio, television set, or wireless installation. These devices can cause radio disturbances which adversely affect the performance of the Controller.

Mounting

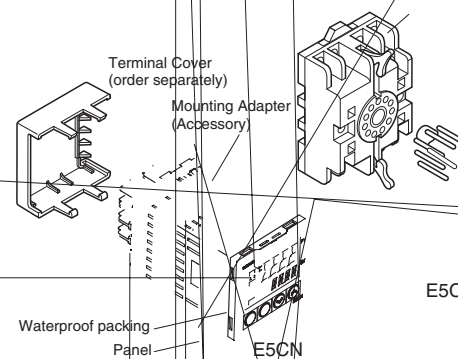

Mounting to a Panel

- To mount the Controller so that it is waterproof, insert the waterproof packing onto the Controller. Group mounting does not allow waterproofing. The waterproof packing is not required if waterproofing is not necessary. The Panel Mounting Adapter is also included with the E5CN-U. Waterproof packing is not included with the E5CN-U.
- Insert the E5CN/E5CN-U into the mounting hole in the panel.
- Push the adapter along the Controller body from the terminals up to the panel, and fasten it temporarily.
- Tighten the two fixing screws on the adapter. Alternately tighten the two screws a little at a time to keep them balanced. Tighten them to a torque of 0.29 to 0.39 N·m.

Attaching the Terminal Cover

Make sure that the "UP" letters on the E5CN are at the top and insert the terminal cover into the holes at the top and bottom of the Controller.

Removing the Controller from the Case

When carrying out maintenance on the Controller, the Controller can be removed from the case with the terminal leads still attached. The Controller can be removed from the case only with the E5CN. It cannot be removed with the E5CN-U.

- Insert the tool into the slots (one on the top and one on the bottom) and release the hooks.
- Insert the tool into the gap between the front panel and rear case and pull out the front panel slightly. Hold both sides of the front panel and draw out the Controller towards you. Do not apply unnecessary force.
- Before inserting the Controller, confirm that the sealing rubber is in place. Insert the Controller into the rear case until you hear a click. Press on the hooks on the top and bottom of the rear case to be sure that the hooks are securely locked in place. Be sure that electronic parts do not come in contact with the case.

Wiring Precautions

- Separate input leads and power lines to protect the Controller and its lines from external noise.
- Use wires of a thickness of AWG24 (0.205 mm²) to AWG14 (2.081 mm²).
The exposed current-carrying part to be inserted into terminals must be 5 to 6 mm.
- We recommend using crimp terminals when wiring the terminals.
- Tighten terminal screws to a torque of 0.74 to 0.90 N·m.
- Use the following type of crimp terminals for M3.5 screws.



1. **Offer; Acceptance.** These terms and conditions (these "Terms") are deemed part of all catalogs, manuals or other documents, whether electronic or in writing, relating to the sale of goods or services (collectively, the "Goods") by Omron Electronics LLC and its subsidiary companies ("Seller"). Seller hereby objects to any terms or conditions proposed in Buyer's purchase order or other documents which are inconsistent with, or in addition to, these Terms. Please contact your Omron representative to confirm any additional terms for sales from your Omron company.
2. **Prices.** All prices stated are current, subject to change without notice by Seller. Buyer agrees to pay the price in effect at time of shipment.
3. **Discounts.** Cash discounts, if any, will apply only on the net amount of invoices sent to Buyer after deducting transportation charges, taxes and duties, and will be allowed only if (i) the invoice is paid according to Seller's payment terms and (ii) Buyer has no past due amounts owing to Seller.
4. **Orders.** Seller will accept no order less than \$200 net billing.
5. **Governmental Approvals.** Buyer shall be responsible for, and shall bear all costs involved in, obtaining any government approvals required for the importation or sale of the Goods.
6. **Taxes.** All taxes, duties and other governmental charges (other than general real property and income taxes), including any interest or penalties thereon, imposed directly or indirectly on Seller or required to be collected directly or indirectly by Seller for the manufacture, production, sale, delivery, importation, consumption or use of the Goods sold hereunder (including customs duties and sales, excise, use, turnover and license taxes) shall be charged to and remitted by Buyer to Seller.
7. **Financial.** If the financial position of Buyer at any time becomes unsatisfactory to Seller, Seller reserves the right to stop shipments or require satisfactory security or payment in advance. If Buyer fails to make payment or otherwise comply with these Terms or any related agreement, Seller may (without liability and in addition to other remedies) cancel any unshipped portion of Goods sold hereunder and stop any Goods in transit until Buyer pays all amounts, including amounts payable hereunder, whether or not then due, which are owing to it by Buyer. Buyer shall in any event remain liable for all unpaid accounts.
8. **Cancellation; Etc.** Orders are not subject to rescheduling or cancellation unless Buyer indemnifies Seller fully against all costs or expenses arising in connection therewith.
9. **Force Majeure.** Seller shall not be liable for any delay or failure in delivery resulting from causes beyond its control, including earthquakes, fires, floods, strikes or other labor disputes, shortage of labor or materials, accidents to machinery, acts of sabotage, riots, delay in or lack of transportation or the requirements of any government authority.
10. **Shipping; Delivery.** Unless otherwise expressly agreed in writing by Seller:
 - a. Shipments shall be by a carrier selected by Seller;
 - b. Such carrier shall act as the agent of Buyer and delivery to such carrier shall constitute delivery to Buyer;
 - c. All sales and shipments of Goods shall be FOB shipping point (unless otherwise stated in writing by Seller), at which point title to and all risk of loss of the Goods shall pass from Seller to Buyer, provided that Seller shall retain a security interest in the Goods until the full purchase price is paid by Buyer;
 - d. Delivery and shipping dates are estimates only.
 - e. Seller will package Goods as it deems proper for protection against normal handling and extra charges apply to special conditions.
11. **Claims.** Any claim by Buyer against Seller for shortage or damage to the Goods occurring before delivery to the carrier must be presented in writing to Seller within 30 days of receipt of shipment and include the original transportation bill signed by the carrier noting that the carrier received the Goods from Seller in the condition claimed.
12. **Warranties.** (a) **Exclusive Warranty.** Seller's exclusive warranty is that the Goods will be free from defects in materials and workmanship for a period of twelve months from the date of sale by Seller (or such other period expressed in writing by Seller). Seller disclaims all other warranties, express or implied. (b) **Limitations.** SELLER MAKES NO WARRANTY OR REPRESENTATION, EXPRESS OR IMPLIED, ABOUT NON-INFRINGEMENT, MERCHANTABILITY OR FITNESS FOR A PARTICULAR PURPOSE OF THE GOODS. BUYER ACKNOWLEDGES THAT IT ALONE HAS DETERMINED THAT THE GOODS WILL SUITABLY MEET THE REQUIREMENTS OF THEIR INTENDED USE. Seller further disclaims all warranties and responsibility of any type for claims or expenses based on infringement by the Goods or otherwise of any intellectual property right. (c) **Buyer Remedy.** Seller's sole obligation hereunder shall be to replace (in the form originally shipped with Buyer responsible for labor charges for removal or replacement thereof) the non-complying Good or, at Seller's election, to repay or credit Buyer an amount equal to the purchase price of the Good; provided that in no event shall Seller be responsible for warranty, repair, indemnity or any other claims or expenses regarding the Goods unless Seller's analysis confirms that the Goods were properly handled, stored, installed and maintained and not subject to contamination, abuse, misuse or inappropriate modification. Return of any goods by Buyer must be approved in writing by Seller before shipment. Seller shall not be liable for the suitability or unsuitability or the results from the use of Goods in combination with any electrical or electronic components, circuits, system assemblies or any other materials or substances or environments. Any advice, recommendations or information given orally or in writing, are not to be construed as an amendment or addition to the above warranty.
13. **Damage Limits; Etc.** SELLER SHALL NOT BE LIABLE FOR SPECIAL, INDIRECT OR CONSEQUENTIAL DAMAGES, LOSS OF PROFITS OR PRODUCTION OR COMMERCIAL LOSS IN ANY WAY CONNECTED WITH THE GOODS, WHETHER SUCH CLAIM IS BASED IN CONTRACT, WARRANTY, NEGLIGENCE OR STRICT LIABILITY. Further, in no event shall liability of Seller exceed the individual price of the Good on which liability is asserted.
14. **Indemnities.** Buyer shall indemnify and hold harmless Seller, its affiliates and its employees from and against all liabilities, losses, claims, costs and expenses (including attorney's fees and expenses) related to any claim, investigation, litigation or proceeding (whether or not Seller is a party) which arises or is alleged to arise from Buyer's acts or omissions under these Terms or in any way with respect to the Goods. Without limiting the foregoing, Buyer (at its own expense) shall indemnify and hold harmless Seller and defend or settle any action brought against Seller to the extent that it is based on a claim that any Good made to Buyer specifications infringed intellectual property rights of another party.
15. **Property; Confidentiality.** The intellectual property embodied in the Goods is the exclusive property of Seller and its affiliates and Buyer shall not attempt to duplicate it in any way without the written permission of Seller. Notwithstanding any charges to Buyer for engineering or tooling, all engineering and tooling shall remain the exclusive property of Seller. All information and materials supplied by Seller to Buyer relating to the Goods are confidential and proprietary, and Buyer shall limit distribution thereof to its trusted employees and strictly prevent disclosure to any third party.
16. **Miscellaneous.** (a) **Waiver.** No failure or delay by Seller in exercising any right and no course of dealing between Buyer and Seller shall operate as a waiver of rights by Seller. (b) **Assignment.** Buyer may not assign its rights hereunder without Seller's written consent. (c) **Amendment.** These Terms constitute the entire agreement between Buyer and Seller relating to the Goods, and no provision may be changed or waived unless in writing signed by the parties. (d) **Severability.** If any provision hereof is rendered ineffective or invalid, such provision shall not invalidate any other provision. (e) **Setoff.** Buyer shall have no right to set off any amounts against the amount owing in respect of this invoice. (f) As used herein, "including" means "including without limitation".

1. **Suitability of Use.** Seller shall not be responsible for conformity with any standards, codes or regulations which apply to the combination of the Good in the Buyer's application or use of the Good. At Buyer's request, Seller will provide applicable third party certification documents identifying ratings and limitations of use which apply to the Good. This information by itself is not sufficient for a complete determination of the suitability of the Good in combination with the end product, machine, system, or other application or use. The following are some examples of applications for which particular attention must be given. This is not intended to be an exhaustive list of all possible uses of this Good, nor is it intended to imply that the uses listed may be suitable for this Good:
 - (i) Outdoor use, uses involving potential chemical contamination or electrical interference, or conditions or uses not described in this document.
 - (ii) Energy control systems, combustion systems, railroad systems, aviation systems, medical equipment, amusement machines, vehicles, safety equipment, and installations subject to separate industry or government regulations.
 - (iii) Systems, machines and equipment that could present a risk to life or property. Please know and observe all prohibitions of use applicable to this Good.
2. **Programmable Products.** Seller shall not be responsible for the user's programming of a programmable Good, or any consequence thereof.
3. **Performance Data.** Performance data given in this catalog is provided as a guide for the user in determining suitability and does not constitute a warranty. It may represent the result of Seller's test conditions, and the user must correlate it to actual application requirements. Actual performance is subject to the Seller's Warranty and Limitations of Liability.
4. **Change in Specifications.** Product specifications and accessories may be changed at any time based on improvements and other reasons. It is our practice to change part numbers when published ratings or features are changed, or when significant construction changes are made. However, some specifications of the Good may be changed without any notice. When in doubt, special part numbers may be assigned to fix or establish key specifications for your application. Please consult with your Seller's representative at any time to confirm actual specifications of purchased Good.
5. **Errors and Omissions.** The information in this catalog has been carefully checked and is believed to be accurate; however, no responsibility is assumed for clerical, typographical or proofreading errors, or omissions.

NEVER USE THE PRODUCT FOR AN APPLICATION INVOLVING SERIOUS RISK TO LIFE OR PROPERTY WITHOUT ENSURING THAT THE SYSTEM AS A WHOLE HAS BEEN DESIGNED TO ADDRESS THE RISKS, AND THAT THE SELLER'S PRODUCT IS PROPERLY RATED AND INSTALLED FOR THE INTENDED USE WITHIN THE OVERALL EQUIPMENT OR SYSTEM.