

公司

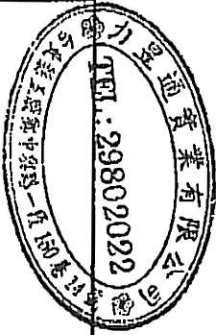

DRAWN

SCALE

DATE

CHECKED

FILE NO

H01-96-Y

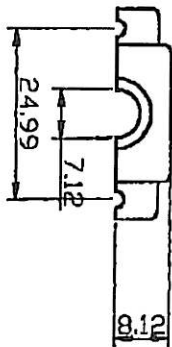
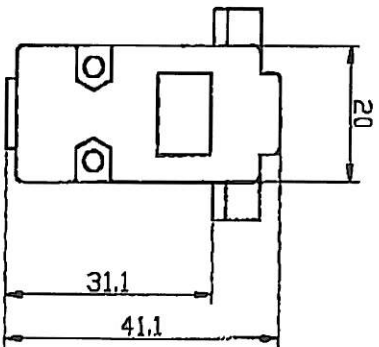
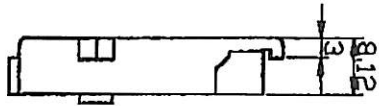
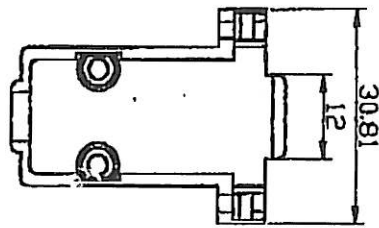

CUSTOMER

FILE NO. BU0004

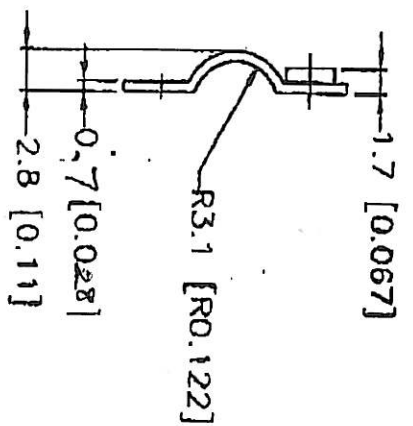
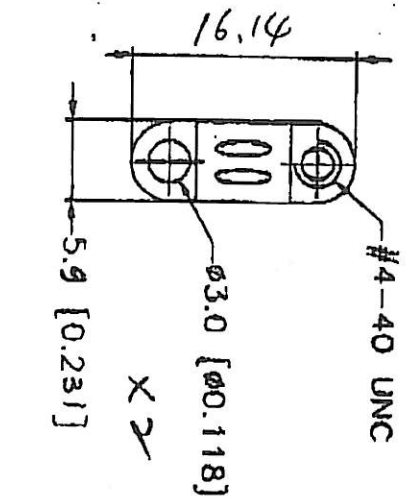

CABLE CLAMP X2pcs

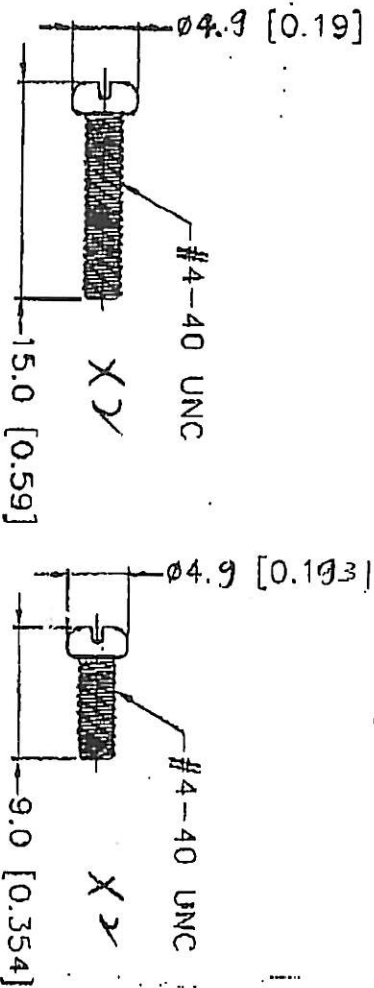
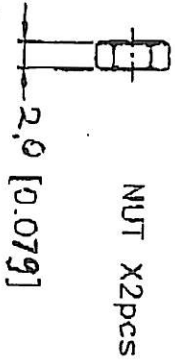
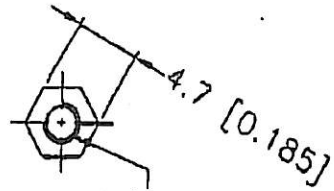
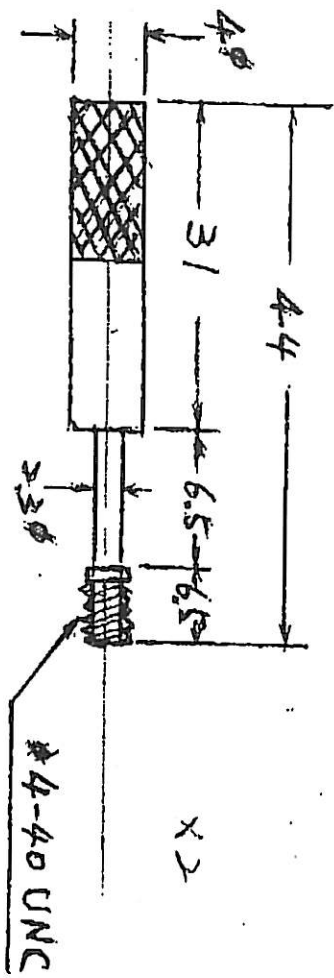

H01-PT 螺絲

DIMENSIONS ARE IN mm (INCH) <b>84N1020</b>	TOLERANCES ARE FRACTIONS DECIMALS ANGLES X ±0.2 (0.008) XX ±0.12 (0.005)	MATERIAL FRENCH	Designer: <b>CHAN</b> DATE: <b>02/11/99</b>
Accessories for <b>3591</b>			Project No. Scale: <b>2/1</b>
			Sheet: <b>2 of 2</b> Reviser: