

PRELIMINARY SPEC

Part Number: SC36-11HWA

BRIGHT RED

### Features

- 0.36 INCH DIGIT HEIGHT.
- LOW CURRENT OPERATION.
- EXCELLENT CHARACTER APPEARANCE.
- EASY MOUNTING ON P.C. BOARDS OR SOCKETS.
- I.C. COMPATIBLE.
- CATEGORIZED FOR LUMINOUS INTENSITY.
- MECHANICALLY RUGGED.
- STANDARD : GRAY FACE, WHITE SEGMENT.
- RoHS COMPLIANT.

### Description

The Bright Red source color devices are made with Gallium Phosphide Red Light Emitting Diode.

### Package Dimensions & Internal Circuit Diagram

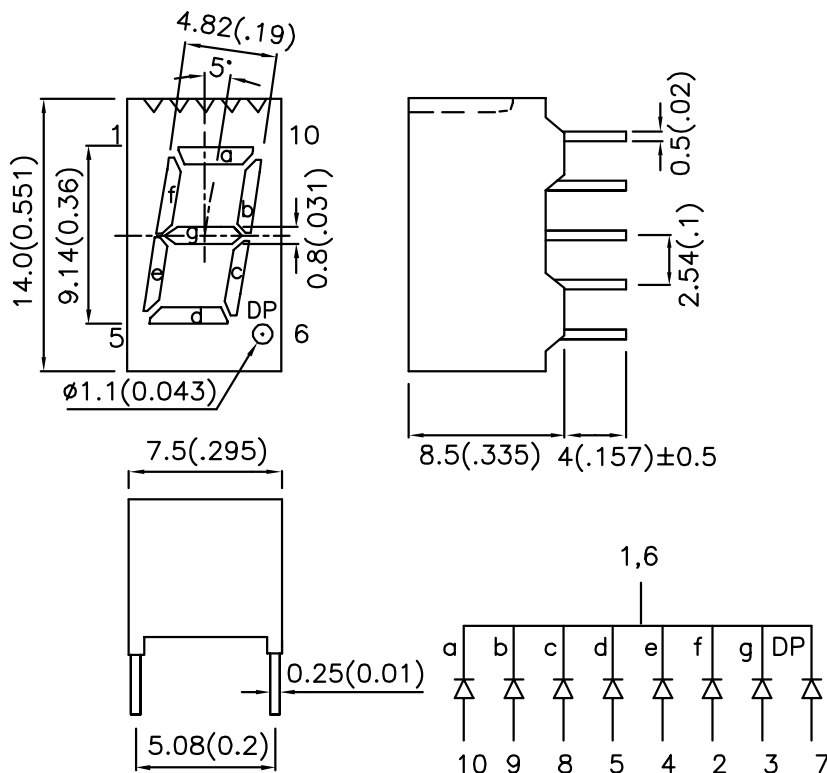

**Notes:**

1. All dimensions are in millimeters (inches), Tolerance is  $\pm 0.25(0.01)$  unless otherwise noted.
2. Specifications are subject to change without notice.



## Selection Guide

Part No.	Dice	Lens Type	Iv (ucd) [1] @ 10mA		Description
			Min.	Typ.	
SC36-11HWA	BRIGHT RED (GaP)	WHITE DIFFUSED	200	816	Common Cathode, Rt. Hand Decimal.

Note:

1. Luminous Intensity / Luminous Flux: +/-15%

## Electrical / Optical Characteristics at TA=25°C

Symbol	Parameter	Device	Typ.	Max.	Units	Test Conditions
$\lambda_{peak}$	Peak Wavelength	Bright Red	700		nm	IF=20mA
$\lambda_D$ [1]	Dominant Wavelength	Bright Red	660		nm	IF=20mA
$\Delta\lambda_{1/2}$	Spectral Line Half-width	Bright Red	45		nm	IF=20mA
C	Capacitance	Bright Red	40		pF	VF=0V;f=1MHz
VF [2]	Forward Voltage	Bright Red	2.25	2.5	V	IF=20mA
IR	Reverse Current	Bright Red		10	uA	VR = 5V

Notes:

1.Wavelength: +/-1nm

2.Forward Voltage: +/-0.1V

## Absolute Maximum Ratings at TA=25°C

Parameter	Bright Red	Units
Power dissipation	62.5	mW
DC Forward Current	25	mA
Peak Forward Current [1]	130	mA
Reverse Voltage	5	V
Operating/Storage Temperature	-40°C To +85°C	
Lead Solder Temperature [2]	260°C For 3~5 Seconds	

Notes:

1. 1/10 Duty Cycle, 0.1ms Pulse Width.

2. 2mm below package base.

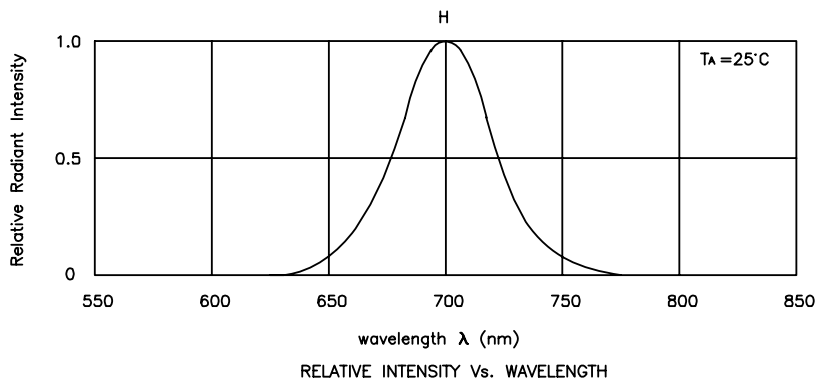

Bright Red

SC36-11HWA

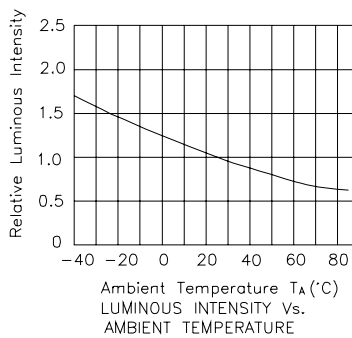
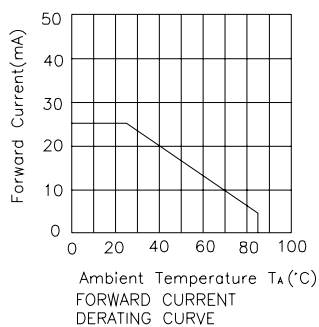
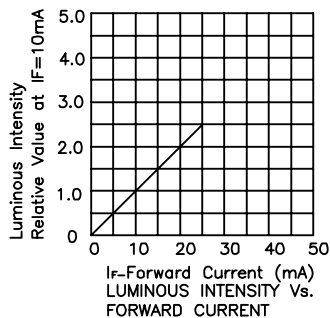
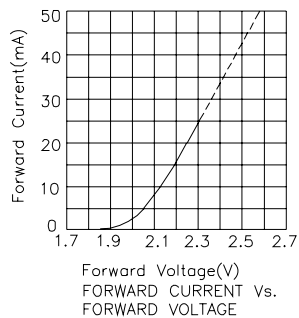

## PACKING & LABEL SPECIFICATIONS

## SC36-11HWA

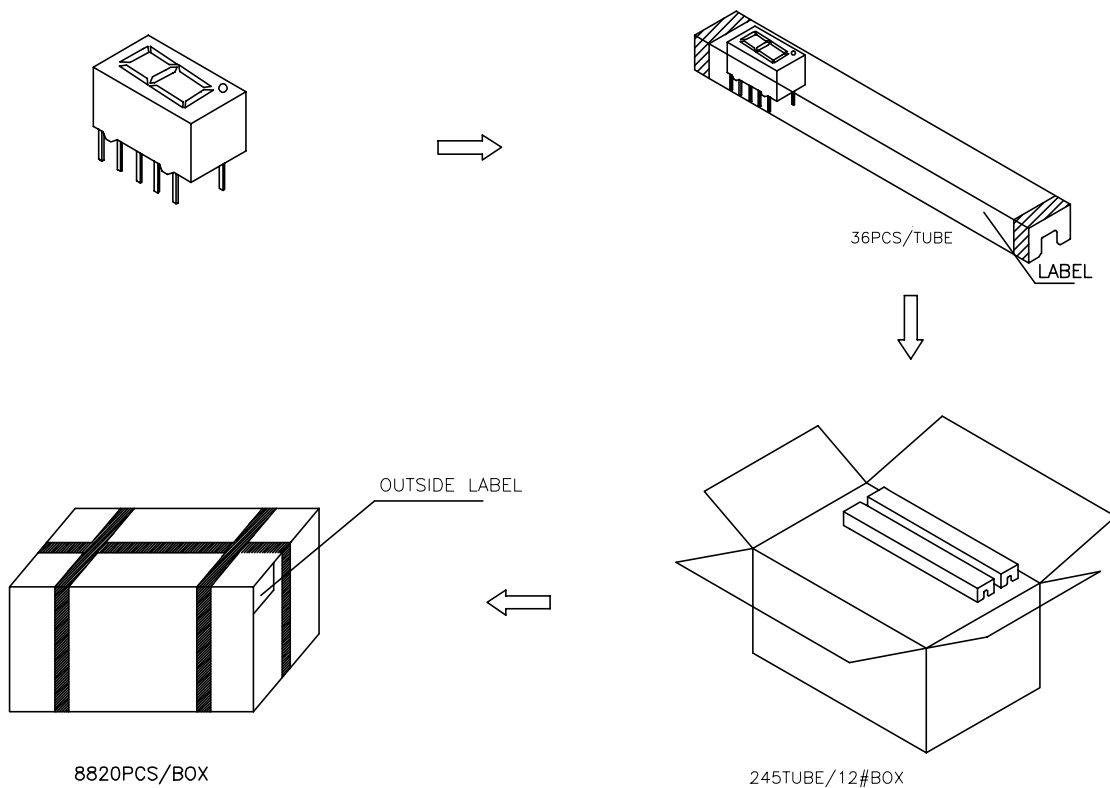

Inside LABEL Paste On The IC-tube

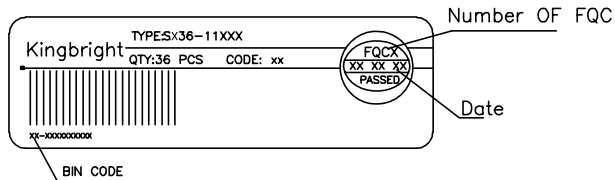

Outside LABEL Paste On The Box

