

<h1>NAIS</h1>	ULTRA-MINIATURE PC BOARD TYPE POWER RELAY	<h1>JS-RELAYS</h1>
---------------	--	--------------------

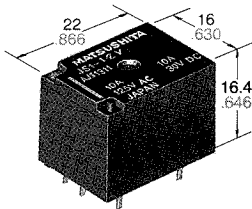

mm inch

UL File No.: E43028
CSA File No.: LR26550

TÜV File No.: 88121645537
VDE File No.: VDE-Reg.-Nr. 4065

- Ultra-miniature size with universal terminal footprint
- High contact capacity: 10 A
- Pick-up voltage: two types (70% and 80% of nominal voltage) available
- Sealed types available
- UL class B coil insulation type available
- TV-5 type available
- UL class C coil insulation type on special request

SPECIFICATIONS

Contact

Arrangement	1 Form A, 1 Form C
Initial contact resistance, max. (By voltage drop 6 V DC 1 A)	100 mΩ
Contact material	Silver alloy
Rating (resistive load)	
Nominal switching capacity	10 A 125 V AC 6 A 277 V AC
Max. switching power	150 W / 1,660 VA
Max. switching voltage	277 V AC, 30 V DC
Max. switching current	10 A (AC), 5 A (DC)
UL/CSA rating	10 A 125, 6 A 277 V AC 1/8 HP 125, 277 V AC 5 A 30 V DC
TÜV rating	10 A 125 V AC (cos φ=1.0) 6 A 250 V AC (cos φ=1.0) 5 A 30 V DC (0 ms)
VDE rating	10 A 125 V ~ (cos φ=1.0) 5 A 30 V ~ (0 ms)
Expected life (min. ope.)	
Mechanical (at 180 cpm)	10 ⁷
Electrical at 10 A 125 V AC, 6 A 277 V AC resistive (at 20 cpm)	10 ⁵

Characteristics

Max. operating speed	20 cpm	
Operate time (at nominal voltage)	Approx. 10 msec.	
Release time (at nominal voltage)	Approx. 10 msec.	
Initial insulation resistance	Min. 100 MΩ (at 500 V DC)	
Initial breakdown voltage		
Between open contacts	750 Vrms for 1 min.	
Between contacts and coil	1,500 Vrms for 1 min.	
Temperature rise (max.) (at nominal voltage)	35 deg.	
Ambient temperature	-40°C to +70°C -40°F to +158°F	
Shock resistance	Functional	Min. 10 G
	Destruction	Min. 100 G
Vibration resistance	Functional	Approx. 10 G 10 to 55 Hz at double amplitude of 1.6 mm
	Destruction	Approx. 12 G 10 to 55 Hz at double amplitude of 2 mm
Unit weight	Approx. 12 g .423 oz	

Coil

Nominal operating power	360 mW
-------------------------	--------

TYPICAL APPLICATION

- | | |
|--|--|
| <ol style="list-style-type: none"> 1. Home appliances
 Air conditioner, heater, etc. 2. Automotive
 Power-window, car antenna, door-lock, etc. | <ol style="list-style-type: none"> 3. Office machines
 PPC, facsimile, etc. 4. Vending machines |
|--|--|

ORDERING INFORMATION

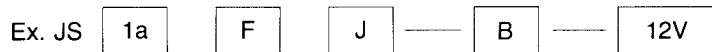

Contact arrangement	Protective construction	Pick-up voltage	Coil insulation class	Coil voltage (DC)
1: 1 Form C 1a: 1 Form A	Nil: Sealed type F: Flux-resistant type	Nil: 70% of nominal voltage J: 80% of nominal voltage	Nil: Class A insulation B: Class B insulation	5, 6, 9, 12, 24, 48 V

- Notes: 1. Standard packing: Carton: 100 pcs. Case: 500 pcs.
2. When ordering TV rated (TV-5) types, add suffix -TV.

TYPES

1. Pick-up voltage: 70% of nominal voltage type

Contact arrangement	Coil voltage, V DC	Part No.	
		Sealed type	Flux-resistant type
1 Form A	5	JS1a-5V	JS1aF-5V
	6	JS1a-6V	JS1aF-6V
	9	JS1a-9V	JS1aF-9V
	12	JS1a-12V	JS1aF-12V
	24	JS1a-24V	JS1aF-24V
1 Form C	5	JS1-5V	JS1F-5V
	6	JS1-6V	JS1F-6V
	9	JS1-9V	JS1F-9V
	12	JS1-12V	JS1F-12V
	24	JS1-24V	JS1F-24V
	48	JS1-48V	JS1F-48V

2. Pick-up voltage: 80% of nominal voltage type

Contact arrangement	Coil voltage, V DC	Part No.	
		Sealed type	Flux-resistant type
1 Form A	5	JS1aJ-5V	JS1aFJ-5V
	6	JS1aJ-6V	JS1aFJ-6V
	9	JS1aJ-9V	JS1aFJ-9V
	12	JS1aJ-12V	JS1aFJ-12V
	24	JS1aJ-24V	JS1aFJ-24V
1 Form C	5	JS1J-5V	JS1FJ-5V
	6	JS1J-6V	JS1FJ-6V
	9	JS1J-9V	JS1FJ-9V
	12	JS1J-12V	JS1FJ-12V
	24	JS1J-24V	JS1FJ-24V
	48	JS1J-48V	JS1FJ-48V

COIL DATA

Nominal voltage, V DC	Pick-up voltage, V DC (max.) (at 20°C 68°F)	Drop-out voltage, V DC (min.) (at 20°C 68°F)	Coil resistance, Ω (±10%) (at 20°C 68°F)	Nominal operating current, mA (±10%) (at 20°C 68°F)	Nominal operating power, mW (at 20°C 68°F)	Max. allowable voltage (at 60°C 140°F)
5	70(80)% of nominal voltage	10% of nominal voltage	69.4	72	360	130%V of nominal voltage
6			100	60		
9			225	40		
12			400	30		
24			1,600	15		
48			6,400	7.5		

DIMENSIONS

mm inch

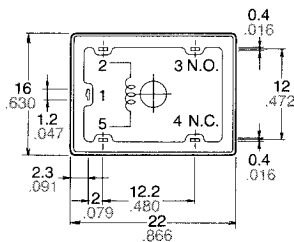
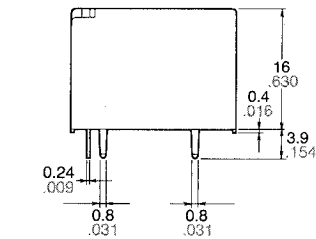
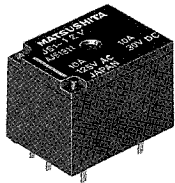

Note: Terminal No. 4 is only for 1 Form C type

General tolerance: ±0.3 ±.012

Schematic (Bottom view)

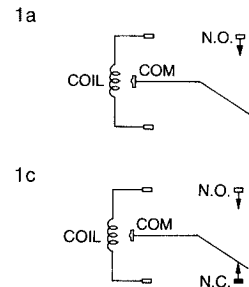

PC board pattern (Copper-side view)

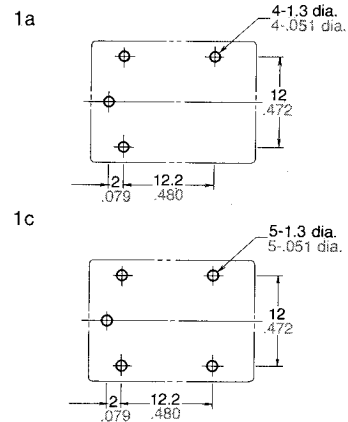

Tolerance: ±0.1 ±.004

DATA

1. Maximum value for switching capacity

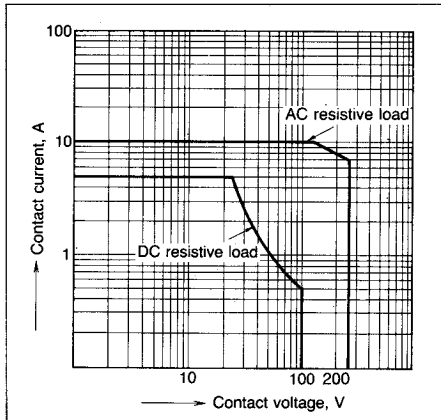

2. Operate/release time
Sample: 25 pcs., JS1-12V

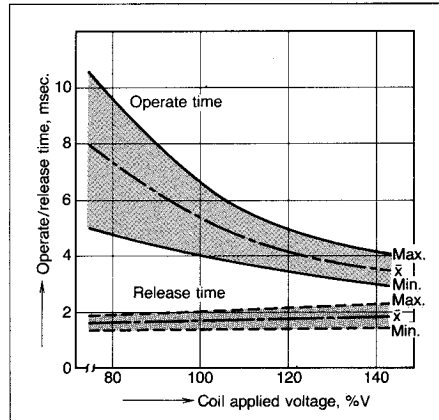

3-(1). Coil temperature rise
Sample: 5 pcs., JS1-12V
Measured portion: Inside the coil
Contact current: 5 A

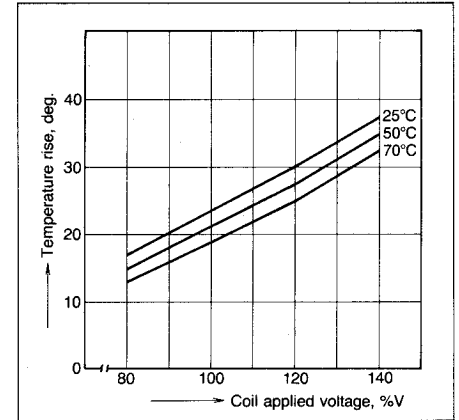

3-(2). Coil temperature rise
Sample: 5 pcs., JS1-12V
Measured portion: Inside the coil
Contact current: 10 A

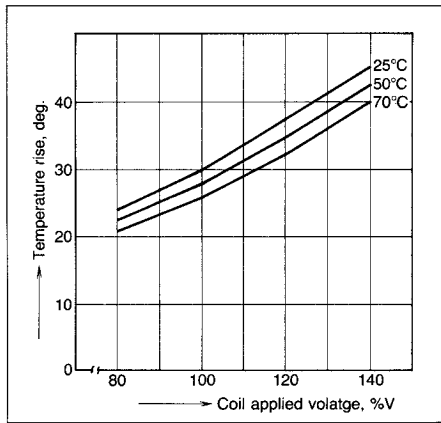

4. Ambient temperature characteristics
Sample: 6 pcs., JS1-12V

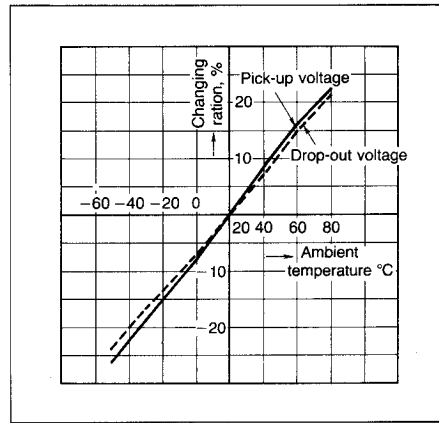

5. Electrical life test (10 A 125 V AC, resistive load)
Sample: 6 pcs., JS1F-12V
Operating speed: 20 cpm.

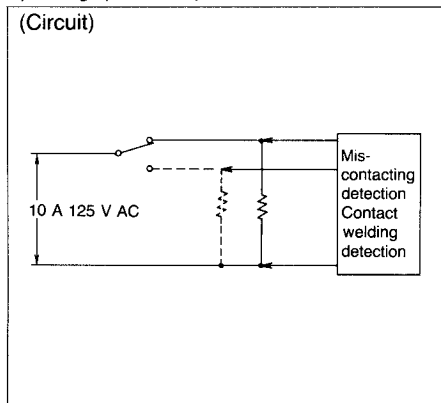

Change of pick-up and drop-out voltage

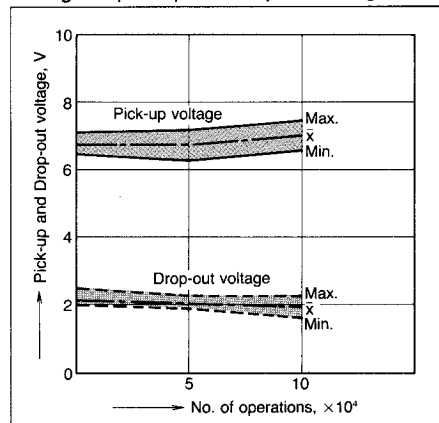

Change of contact resistance

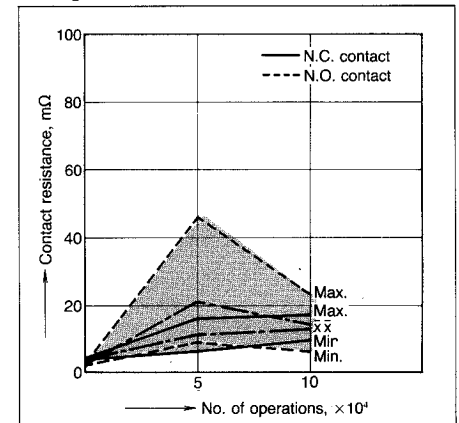

NOTES

- To maintain initial performance, care should be taken to avoid dropping or hitting the relay.
- Avoid using in the location where there is excessive dust or organic gas such as SO₂ gas and H₂S gas. Note that switching contact in the silicon atmosphere may result in contact failure.
- The voltage applied to coil should not exceed the max. switching voltage.
- The voltage applied to coil should be nominal voltage with rectangular wave.
- The switching voltage and current to the contact should not exceed the rated value.
- The rated contact capacity and life are typical values. Since contact phenomena and life vary depending on kinds of load and other conditions, please examine them through actual conditions.
- Relays should be used within the rated ambient temperature.
- For automatic cleaning, use sealed types. It is recommended that fluorinated hydrocarbon or other alcoholic solvent be used, and that the ultrasonic cleaning be avoided.
- Avoid bending terminals, because it may cause malfunction.