

PART No. 1444-26

for more information visit
www.hammondmfg.com

Data subject to change without notice

ISOMETRIC VIEW NOT TO SCALE

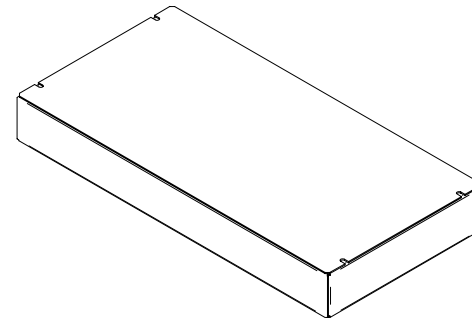
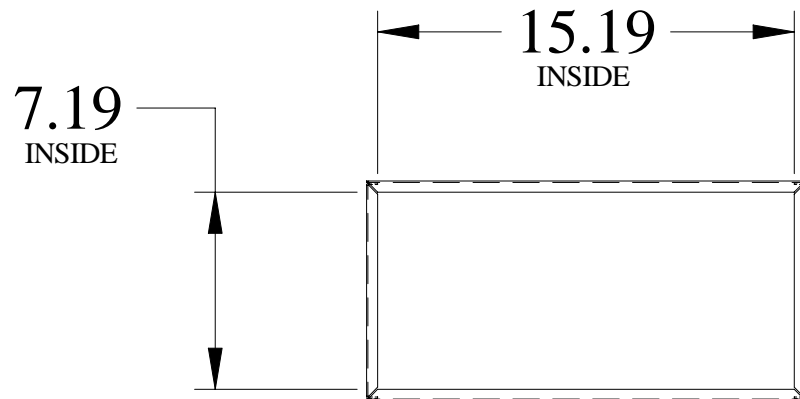

LID REMOVED FOR CLARITY

