

# 319

## CUSTOMIZED

AUTO-BLOQUEO SELF-LOCKING COUPLE D'AUTOBLOCAGE SELBSTHEMMUNG	✓
RUEDA DE BRONCE BRONZE WHEEL ROUE EN BRONZE GETRIEBERAD AUS BRONZE	✓
EJE DELANTERO Y POSTERIOR FRONT AND REAR SHAFT ARBRE ARRIERE VORDERWELLE UND HINTERWELLE	✓
SENSOR HALL HALL SENSOR CAPTEUR HALL HALLSENSOR	✓

Y MUCHO MÁS - AND MANY MORE  
ET BEAUCOUP D'AUTRES - UND VIELEN ANDEREN

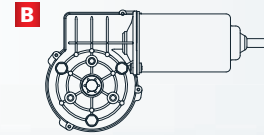
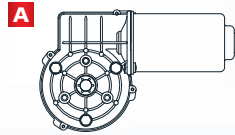

REFERENCIA REFERENCE NUMBER REFERENZNUMMERN	TENSION NOMINAL NOMINAL VOLTAGE TENSION NOMINALE NENNSPANNUNG	PAR NOMINAL NOMINAL TORQUE COUPLE NOMINAL DREHMOMENT NOMINAL	VELOCIDAD NOMINAL NOMINAL SPEED VITESSE NOMINALE GESCHWINDIGKEIT NOMINAL	CORRIENTE NOMINAL NOMINAL CURRENT COURANT NOMINAL NOMINALSTROM	PAR DE ARRANQUE STARTING TORQUE COUPLE DE DEMARRAGE ANZUGSDREHMOMENT	CORRIENTE DE ARRANQUE STARTING CURRENT COURANT DE DEMARRAGE ANLAUFSTROM	EJE SHAFT ARBRE WELLE	CONEXIONES CONNECTIONS CONNEXIONS ANSCHLUSSART	ESQUEMA ELÉCTRICO WIRING DIAGRAM SCHEMA ELECTRIQUE SCHALTBILD	RELACION DE REDUCCIÓN TRANSMISSION RATIO RAPPORT DE REDUCTEUR UNTERSETZUNG	PESO APROXIMADO APPROXIMATE WEIGHT POIDS APPROXIMATIF GEWICHT (ca.)	GRADO DE ESTANQUEIDAD WATER TIGHTNESS ÉTANCHÉITÉ FEUCHTIGKEITSSCHUTZKLASSE	MATERIAL RUEDA WHEEL MATERIAL MATERIAU ROUE MAT. DES SCHNECKENRADES	DESIGN: A,B,C DESSIN: A,B,C ABBILDUNG: A,B,C	CURVA CURVE COURBE KURVE
	Un (V)	Mn (N.m./lbf.in)	nn (r.p.m.)	In (A)	Ma (N.m./lbf.in)	Ia (A)				i	P (kg/lb.t)	IP			
319.1846.20.00	12	4 / 35	85	7	40 / 354	60	E35	C37	F5	78:2	1.7 / 4.55	IP65	PLA	a	62
319.1846.30.00	24	4 / 35	85	3.5	40 / 354	30	E35	C37	F5	78:2	1.7 / 4.55	IP65	PLA	a	62
319.1860.20.00	12	9 / 79.6	30	7	50 / 442	28	E35	C37	F5	81:1	1.7 / 4.55	IP65	PLA	a	58
319.1860.30.00	24	9 / 79.6	30	3	50 / 442	15	E35	C37	F5	81:1	1.7 / 4.55	IP65	PLA	a	58
319.1862.20.00	12	8 / 70.8	45	6	50 / 442	50	E35	C37	F5	81:1	1.7 / 4.55	IP65	PLA	a	60
319.1862.30.00	24	9 / 79.6	45	3	60 / 531	25	E35	C37	F5	81:1	1.7 / 4.55	IP65	PLA	a	61
319.3820.20.00	12	9 / 79.6	30	7	50 / 442	28	E35	C37	EE4	81:1	1.7 / 4.55	IP65	BRO	a	58
319.3820.30.00	24	9 / 79.6	30	3	50 / 442	15	E35	C37	EE4	81:1	1.7 / 4.55	IP65	BRO	a	58
319.3822.20.00	12	8 / 70.8	45	6	50 / 442	50	E35	C37	EE4	81:1	1.7 / 4.55	IP65	BRO	a	60
319.3822.30.00	24	9 / 79.6	45	3	60 / 531	25	E35	C37	EE4	81:1	1.7 / 4.55	IP65	BRO	a	61
319.3845.20.00	12	6 / 53.1	65	8	35 / 309	40	E35	C37	EE4	78:2	1.7 / 4.55	IP65	PLA	a	67
319.3845.30.00	24	6 / 53.1	65	4	40 / 354	25	E35	C37	EE4	78:2	1.7 / 4.55	IP65	PLA	a	67
319.3846.20.00	12	4 / 35	85	7	40 / 354	60	E35	C37	EE4	78:2	1.7 / 4.55	IP65	PLA	a	62
319.3846.30.00	24	4 / 35	85	3.5	40 / 354	30	E35	C37	EE4	78:2	1.7 / 4.55	IP65	PLA	a	62
319.3860.20.00	12	9 / 79.6	30	7	50 / 442	28	E35	C37	EE4	81:1	1.7 / 4.55	IP65	PLA	a	58
319.3860.30.00	24	9 / 79.6	30	3	50 / 442	15	E35	C37	EE4	81:1	1.7 / 4.55	IP65	PLA	a	58
319.3862.20.00	12	8 / 70.8	45	6	50 / 442	50	E35	C37	EE4	81:1	1.7 / 4.55	IP65	PLA	a	60
319.3862.30.00	24	9 / 79.6	45	3	60 / 531	25	E35	C37	EE4	81:1	1.7 / 4.55	IP65	PLA	a	61
319.9059.30.00	24	2.2 / 19.47	230	4	20 / 177	36	E35	C37	EE4	68:4	1.7 / 4.55	IP65	PLA	a	65
319.9128.30.00	24	2.2 / 19.47	230	4	20 / 177	36	E35/E66	C38	EE4	68:4	1.7 / 4.55	IP40	PLA	b	65
319.9137.20.00	12	2 / 17.7	155	8	20 / 177	60	E35	C38	EE4	68:4	1.7 / 4.55	IP65	PLA	a	66
319.9137.30.00	24	2 / 17.7	175	4	20 / 177	30	E35	C38	EE4	68:4	1.7 / 4.55	IP65	PLA	a	66

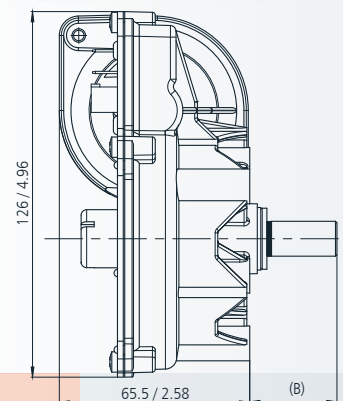
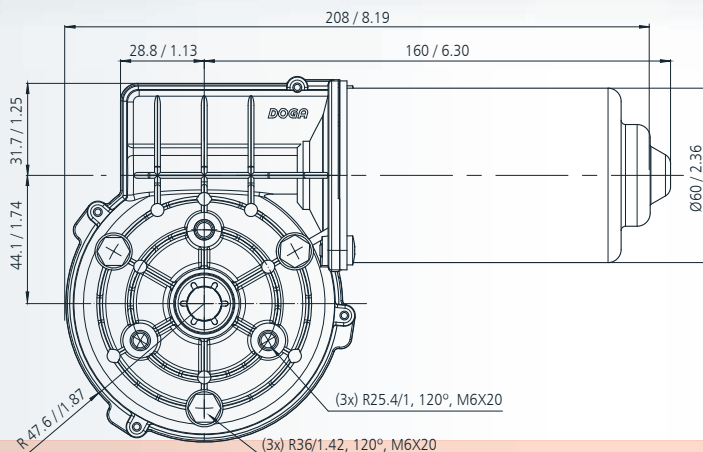

mm / inch

**DOGA**

EJE - SHAFT - ARBRE - WELLE

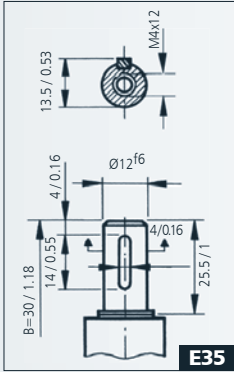

**E35**

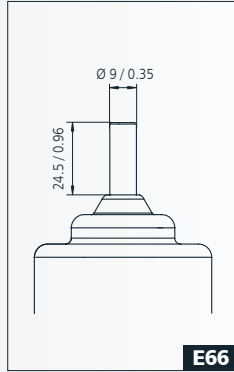

**E66**

CONEXIONES - CONNECTIONS  
CONNEXIONS - ANSCHLUSSART

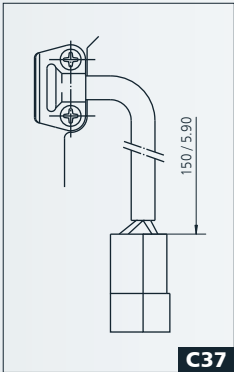

**C37**

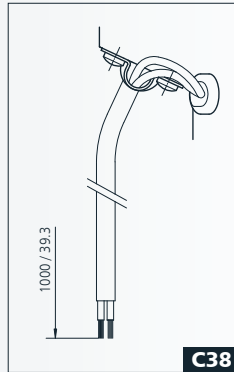

**C38**

ESQUEMA ELÉCTRICO - WIRING DIAGRAM  
SCHEMA ÉLECTRIQUE - SCHALTBILD

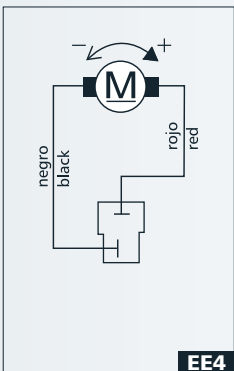

**EE4**

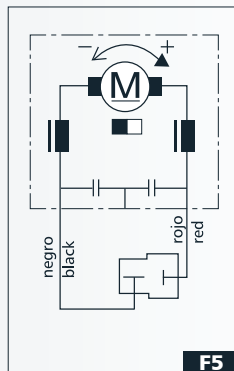

**F5**

CURVAS - CURVES - COURBES - KURVEN

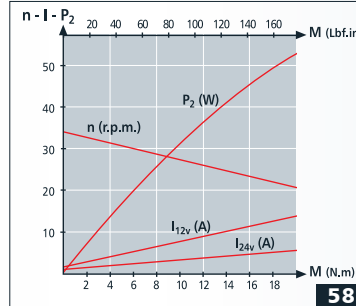

**58**

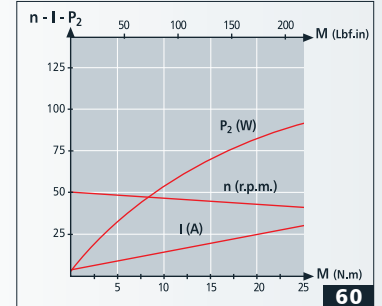

**60**

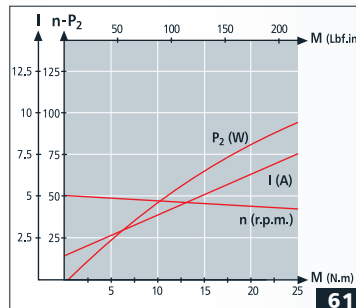

**61**

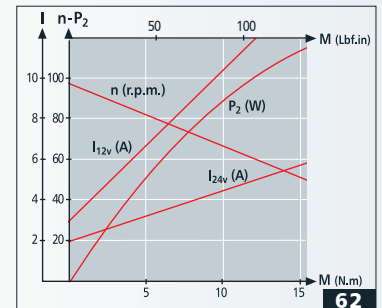

**62**

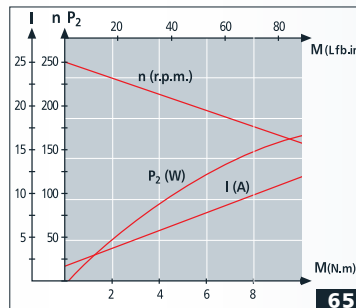

**65**

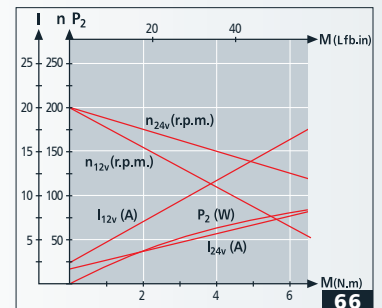

**66**

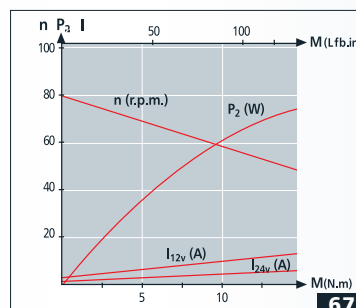

**67**