

Enclosures can be Factory Modified ( Milling, Drilling, Printing etc. )  
 Contact Factory [mjm@hammondmfg.com](mailto:mjm@hammondmfg.com) for quotes  
 Solid models of this enclosure available in STEP or IGES.

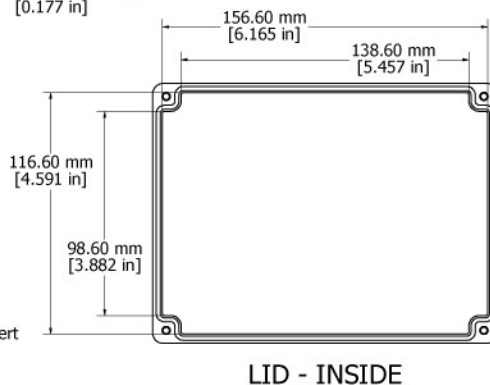

<b>RP1245</b>
Material: ABS (UL94-HB), Light Gray Color
Lid Screws: M3.5 x 10, 304 Stainless
Gasket: EDPM Cord.
Circuit Board Screws, 4 Supplied (M3 self tap)
Suggested Lid Screw Torque: 30 ozf-in (21 cN-m)

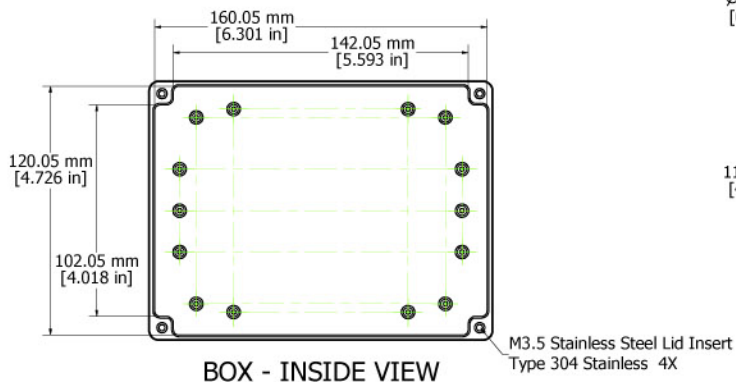

**HAMMOND  
MANUFACTURING™**

**RP1245**

[www.hammondmfg.com](http://www.hammondmfg.com)