

SILICON PLANAR EPITAXIAL TRANSISTORS

BC327/A BC328 PNP
BC337/A BC338 NPN

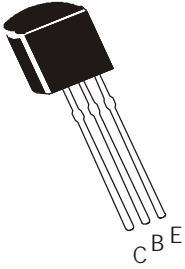

TO-92
Plastic Package

For Lead Free Parts, Device Part #
will be Prefixed with "T"

General Purpose Transistors Best Suited for use in Driver and Output Stages of Audio Amplifier

ABSOLUTE MAXIMUM RATINGS ($T_a=25^\circ\text{C}$)

DESCRIPTION	SYMBOL	BC327/337	BC327A/337A	BC328/338	UNITS
Collector Emitter Voltage	V_{CEO}	45	60	25	V
Collector Emitter Voltage	V_{CES}	50	60	30	V
Emitter Base Voltage	V_{EBO}	5			V
Collector Current Continuous	I_C	800			mA
Collector Current Peak	I_{CM}	1000			mA
Emitter Current Peak	I_{EM}	1000			mA
Base Current Continuous	I_B	100			mA
Base Current Peak	I_{BM}	200			mA
Power Dissipation at $T_a=25^\circ\text{C}$	P_D	625			mW
Derate Above 25°C		5			mW/ $^\circ\text{C}$
Operating And Storage Junction Temperature Range	T_j, T_{stg}	- 65 to +150			$^\circ\text{C}$

THERMAL RESISTANCE

Junction to Ambient in free air	$R_{th(j-a)}$	200	$^\circ\text{C}/\text{W}$
---------------------------------	---------------	-----	---------------------------

ELECTRICAL CHARACTERISTICS ($T_a=25^\circ\text{C}$ unless specified otherwise)

DESCRIPTION	SYMBOL	TEST CONDITION	MIN	MAX	UNITS
Collector Emitter Voltage	V_{CEO}	$I_C=1\text{mA}, I_B=0$			
		BC327/337	45		V
		BC327A/337A	60		V
Collector Emitter Voltage	V_{CES}	$I_C=100\mu\text{A}, I_E=0$			
		BC327/337	50		V
		BC327A/337A	60		V
		BC328/338	30		V
Emitter Base Voltage	V_{EBO}	$I_E=10\mu\text{A}, I_C=0$	5.0		V
Collector Cut Off Current	I_{CBO}	$V_{CB}=20\text{V}, I_E=0$		100	nA
		$V_{CB}=20\text{V}, I_E=0, T_J=150^\circ\text{C}$		5	μA
Emitter Cut Off Current	I_{EBO}	$V_{EB}=5\text{V}, I_C=0$		10	μA
Collector Emitter Saturation Voltage	$*V_{CE(sat)}$	$I_C=500\text{mA}, I_B=50\text{mA}$		0.7	V
Base Emitter On Voltage	$*V_{BE(on)}$	$I_C=500\text{mA}, V_{CE}=1\text{V}$		1.2	V

*Pulse Test: Pulse Width $\leq 300\text{ms}$, Duty Cycle $\leq 2\%$

SILICON PLANAR EPITAXIAL TRANSISTORS

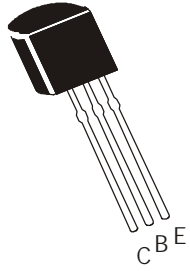

BC327/A BC328 PNP
BC337/A BC338 NPN

TO-92
Plastic Package

For Lead Free Parts, Device Part #
 will be Prefixed with "T"

ELECTRICAL CHARACTERISTICS ($T_a=25^\circ\text{C}$ unless specified otherwise)

DESCRIPTION	SYMBOL	TEST CONDITION	MIN	MAX	UNITS
DC Current Gain	* h_{FE}	$I_C=100\text{mA}$, $V_{CE}=1\text{V}$			
		BC327A/337A	100	400	
		BC327/328, BC337/338	100	600	
		BC327/328, BC337/338			
		Group-10	63	160	
		Group-16	100	250	
		$I_C=500\text{mA}$, $V_{CE}=1\text{V}$			
		Group-25	160	400	
		Group-40	250	600	
			40		

SMALL SIGNAL CHARACTERISTICS

DESCRIPTION	SYMBOL	TEST CONDITION	TYP	UNITS
Transistors Frequency	f_T	$I_C=10\text{mA}$, $V_{CE}=5\text{V}$, $f=35\text{MHz}$		
		NPN	200	MHz
		PNP	100	MHz
Output Capacitance	C_{ob}	$V_{CB}=10\text{V}$, $I_E=0$, $f=1\text{MHz}$		
		NPN	5	pF
		PNP	8	pF

*Pulse Test: Pulse Width $\leq 300\mu\text{s}$, Duty Cycle $\leq 2\%$

BC327_338Rev_3 290606D

TO-92 Leaded Plastic Package

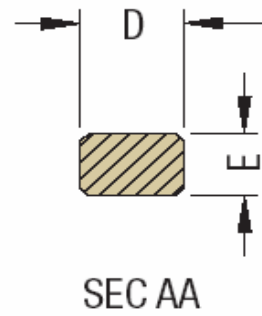
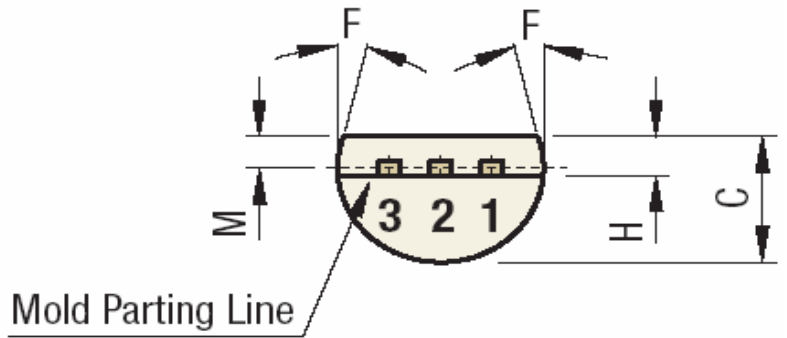
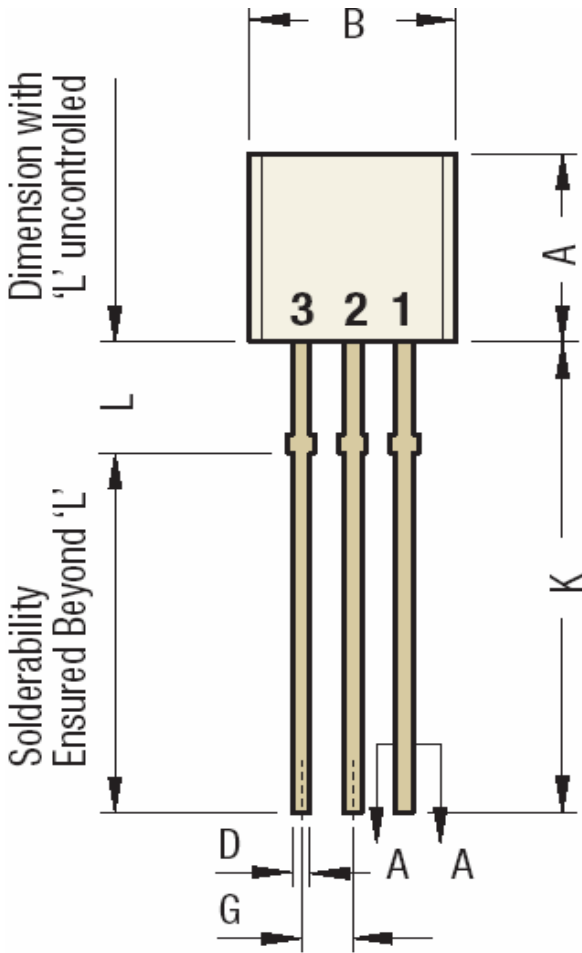

DIM	Min	Max
A	4.32	5.33
B	4.45	5.20
C	3.18	4.19
D	0.40	0.55
E	0.30	0.55
F	5°	

All Dimensions are in mm

DIM	Min	Max
G	1.14	1.40
H	1.20	1.80
K	12.5	
L	1.982	2.082
M	1.03	1.53

- Pin 1 Emitter
- Pin 2 Base
- Pin 3 Collector

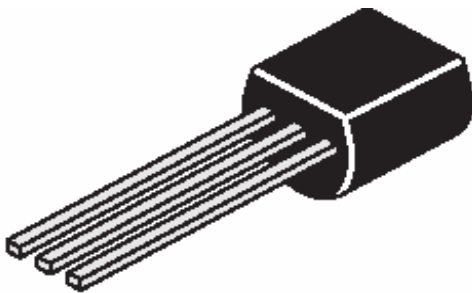

TO-92 Tape and Ammo Packaging

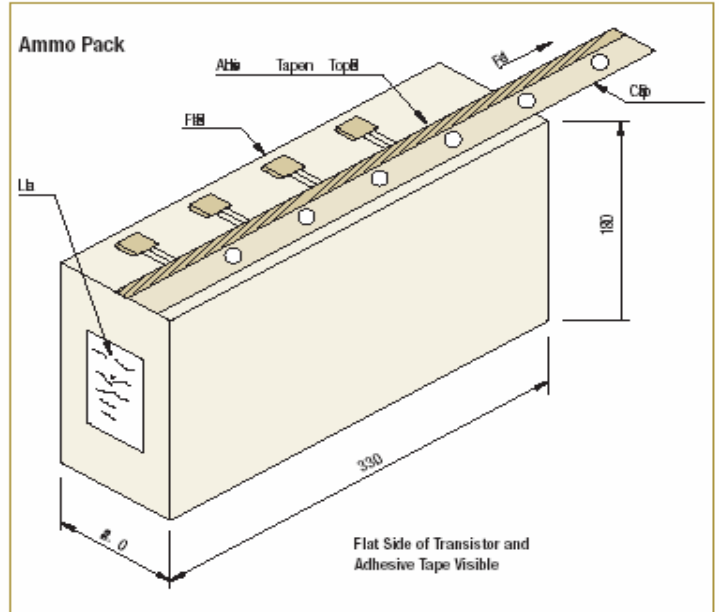
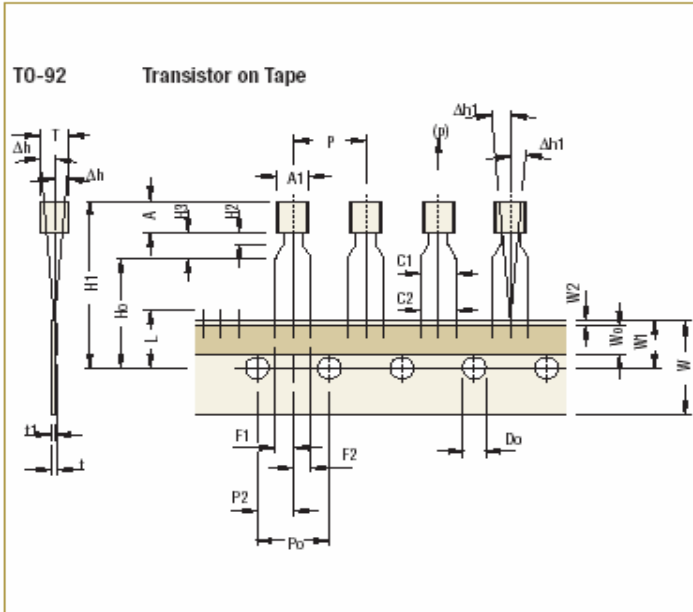

All Dimensions are in mm

Tape Specifications

Item description	Symbol	TO-92			
		Min	Nom	Max	Tol
Body width	A1	4.45		5.20	
Body height	A	4.32		5.33	
Body thickness	T	3.18		4.19	
Pitch of component ^{Cr}	P		12.7		±1.0
Feed hole pitch ^{§1}	P0		12.7		±0.3
Feed hole center to component centre ^{§2}	P2		6.35		±0.4
Comp. alignment, Side view ^{§3}	Dh		0	1.0	
Comp. alignment, Front view ^{§3}	Dh1		0	1.3	
Tape width ^{Cr}	W		18		±0.5
Hold down tape width ^{Cr}	W0		6		±0.2
Hole position	W1		9		+0.7 -0.5
Hold-down tape position	W2	0.0		0.7	
Lead wire clinch height	Ho		16		±0.5
Component height	H1			24.0	
Length of snapped leads	L			11.0	
Feed hole diameter ^{Cr}	Do		4		±0.2
Total tape thickness ^{§4}	t			1.2	
Lead-to-lead distance ^{Cr}	F1, F2	2.4		2.7	
Stand off	H2	0.45		1.45	
Clinch height	H3			3.0	
Lead parallelism ^{Cr}	C1-C2			0.22	
Pull-out force	(p)	6N			

Taping Specification

- Maximum alignment deviation between leads not to be greater than 0.20 mm.
- Maximum non-cumulative variation between tape feed holes shall not exceed 1 mm in 20 pitches.
- Hold down tape not to exceed beyond the edge(s) carrier tape and there shall be no exposure of adhesive.
- No more than 3 consecutive missing components is permitted.
- A tape trailer, having at least three feed holes is required after the last component.
- Splices shall not interfere with the sprocket feed holes.

§1 Cumulative pitch error 1.0 mm/20 pitch.

§2 To be measured at bottom of clinch.

§3 At top of body.

§4 t1 = 0.3 – 0.6 mm

Cr Critical Dimension.

All Dimensions are in mm

Packaging Information

T & A: Tape and Ammo Pack; T & R: Tape and Red; Bulk: Loose in Poly bags; Tube: Tube and Ammo Pack; k: 1.000

Package/Case Type	Packaging Type	Std. Packing		Inner Carton		Outer Carton		
		Qty	Qty	Size L x W x H (cm)	Gross Weight (Kg)	Qty	Size L x W x H (cm)	Gross Weight (Kg)
TO-92	Bulk	1,000	5K	19x19x8	1.10	80K	43x40x35	20.0
	T&A	2,000	2K	32x4.5x20	0.70	40K	43x40x35	15.20

Component Disposal Instructions

1. CDIL Semiconductor Devices are RoHS compliant, customers are requested to please dispose as per prevailing Environmental Legislation of their Country.
2. In Europe, please dispose as per EU Directive 2002/96/EC on Waste Electrical and Electronic Equipment (WEEE).

Customer Notes

Disclaimer

The product information and the selection guides facilitate selection of the CDIL's Semiconductor Device(s) best suited for application in your product(s) as per your requirement. It is recommended that you completely review our Data Sheet(s) so as to confirm that the Device(s) meet functionality parameters for your application. The information furnished in the Data Sheet and on the CDIL Web Site/CD are believed to be accurate and reliable. CDIL however, does not assume responsibility for inaccuracies or incomplete information. Furthermore, CDIL does not assume liability whatsoever, arising out of the application or use of any CDIL product; neither does it convey any license under its patent rights nor rights of others. These products are not designed for use in life saving/support appliances or systems. CDIL customers selling these products (either as individual Semiconductor Devices or incorporated in their end products), in any life saving/support appliances or systems or applications do so at their own risk and CDIL will not be responsible for any damages resulting from such sale(s).CDIL strives for continuous improvement and reserves the right to change the specifications of its products without prior notice.

