







Certificate  E309588

NO:	3		NO:	4	
	变更内容 TEVISION	日期 DATE		变更内容 TEVISION	日期 DATE
					
					
					

A

A

版本 R.NO.	R 0			
制图 DRAWN	LIAO	审核 AUDIT		核准 CHECK

B

B

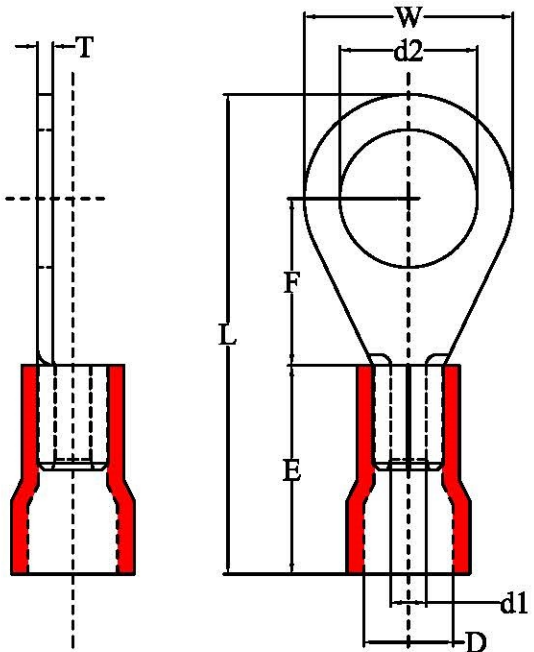

C

C

NO.	ITEM	INSULATION COLOR	WIRE RANGE AND I Max	PRODUCT SIZE: mm							
				d2	W	F	L	E	D	d1	T
1	FVWS1.25-3(LF)	RED	0.5-1.5mm ² A.W.G: 22-16 I MAX: 19A	3.2	5.5	4.8	17.5	10.0	4.3	1.7	0.75
2	FVWS1.25-3.7(LF)			3.7	5.5	4.8	17.5				
3	FVWS1.25-M4(LF)			4.3	6.6	6.3	19.4				
4	FVWS1.25-5(LF)			5.3	8.0	7.0	20.8				
5	FVWS1.25-8(LF)			8.4	11.8	11.0	26.7				
6	FVWS1.25-10(LF)			10.5	13.6	13.9	30.5				
7	FVWS2-S3.3	BLUE	1.5-2.5mm ² A.W.G: 16-14 I MAX: 27A	3.2	6.6	4.7	17.8	10.0	4.8	2.3	0.8
8	FVWS2-M3			3.7							
9	FVWS2-4			4.3	8.5	6.3	19.5				
10	FVWS2-M4			4.3	6.6	7.8	21.8				
11	FVWS2-M5			5.3	8.5	7.8	21.8				
12	FVWS2-8			8.4	11.8	11.0	26.8				
13	FVWS5.5-S3(LF)	YELLOW	4-6mm ² A.W.G: 12-10 I MAX: 48A	3.8	7.2	6.1	22.7	13.0	6.3	3.4	1.0
14	FVWS5.5-S4(LF)			4.4							
15	FVWS5.5-5(LF)			5.4	9.5	8.3	27.3				
16	FVWS5.5-6(LF)			6.4	12.0	10.5	29.5				

D

D

E

E

产品编号 ITEM NO.	RV SERIES	端子材质 TERMINAL MATERIAL	Copper		单位 UNIT: mm
客户编号 PAT NO.		金属厚度 THICKNESS		规格 WIRE RANGE:	
比例 SCALE		绝缘材质 INSULATION MATERIAL	VINYL	温度与电压 MAXIMUM temperature and voltage:	75°C 600 VOLTS MAX.
日期 DATE	2015.12.10	颜色 COLOR		电流 MAXIMUM ELECTRICAL RATING:	

F

F

1 | 2 | 3 | 4