

◆ Absolute Maximum Ratings at TA=25°C

Parameter	Symbol	Value	Unit
Power Dissipation	PD	50	mW
Forward Current	IF	30	mA
Peak Forward Current*1	IFP	100	mA
Reverse Voltage	VR	5	V
Operating Temperature	Topr	-40°C To +80°C ▲	
Storage Temperature	Tstg	-40°C To +85°C	
Soldering Temperature*2	Tsol	260°C For 5 Seconds Δ	

Notes:

*1: Pulse width≤0.1ms, Duty cycle≤1/10

*2: ΔAt the position of 3mm below package base.

*3: ▲Please refer to the curve of forward current vs.temperature

◆ Electrical / Optical Characteristics at TA=25°C

Parameter	Symbol	Min	Typ	Max	Unit	Test Conditions
Forward Voltage	VF	1.8	1.95	2.6	V	IF=20mA
Reverse Current	IR	—	—	10	μA	VR=5V
Dominant Wavelength	λ_d	618	623	628	nm	IF=20mA
Peak Wavelength	λ_P	—	635	—	nm	IF=20mA
Spectral line Half-width	$\Delta\lambda$	—	20	—	nm	IF=20mA
Luminous Intensity	IV	1700	3500	5700	mcd	IF=20mA
Power Angle	$2\theta_{1/2}$	—	10	—	Deg.	IF=20mA

Remarks:

If special sorting is required (e.g. binning based on forward voltage, luminous intensity, or dominant wavelength), the typical accuracy of the sorting process is as follows:

1. Dominant Wavelength: +/-1nm
2. Chromatic Coordinates: +/-0.01
3. Luminous Intensity: +/-15%

◆ Features

- 5mm Rounded LED Lamps
- Emitting Color: Red
- Lens Color: Water Clear
- Material: AlGaInP
- Low power consumption
- Excellent product quality and reliability
- Lead-free device

◆ Applications

- Electronic signs and signals
- Bright ambient lighting conditions
- Backlight
- General purpose indicators

◆ Package Dimensions

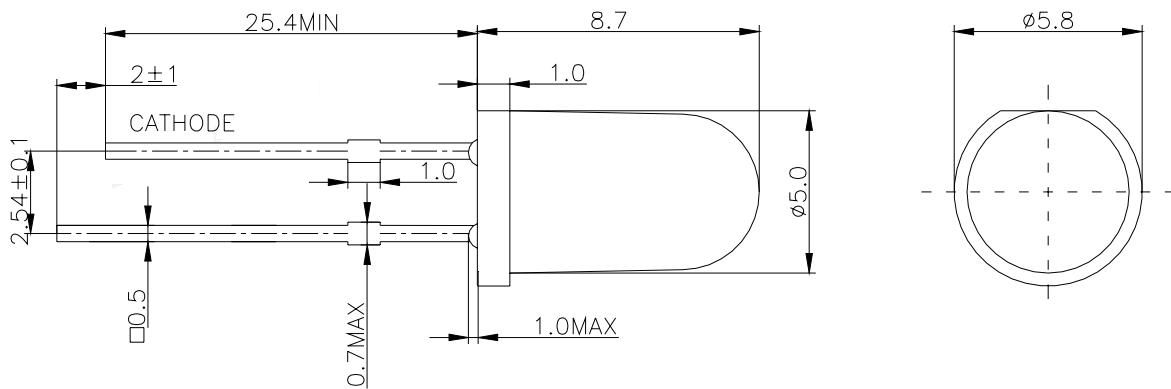

Notes:

1. All dimensions are in millimeters.
 2. Tolerance is ± 0.25 unless otherwise noted.
 3. Lead spacing is measured where the leads emerge from the package.
 4. Specifications are subject to change without notice.
 5. The design and working Current for Led is not less than 2mA.
-

◆ **Forward Voltage Combination (V at 20mA)**

Rank	VF(V)		Condition
	Min	Max	
A2B1	1.8	2.0	IF=20mA
B2C1	2.0	2.2	
C2D1	2.2	2.4	
D2E1	2.4	2.6	

Tolerance:±0.1V

◆ **Dominant Wavelength Combination (λ_D at 20mA)**

Rank	λ_D (nm)		Condition
	Min	Max	
RB	618	623	IF=20mA
RC	623	628	

Tolerance:±1nm

◆ **Luminous Intensity Combination (mcd at 20mA)**

Rank	IV(mcd)		Condition
	Min	Max	
O	1700	2500	IF=20mA
P	2500	3800	
P1	3800	5700	

Tolerance:±15%

◆ Typical Electrical/Optical Characteristics Curves

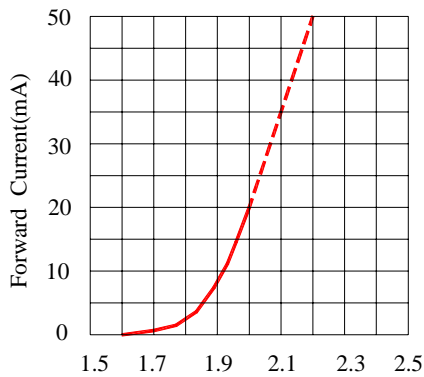

FORWARD CURRENT Vs.
FORWARD VOLTAGE

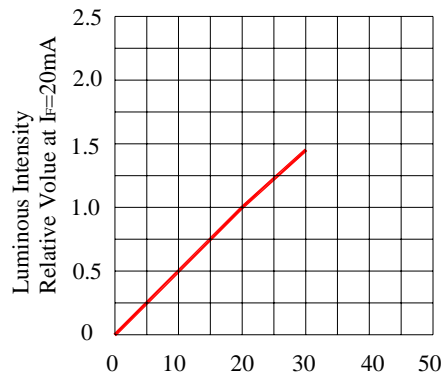

LUMINOUS INTENSITY Vs.
FORWARD CURRENT

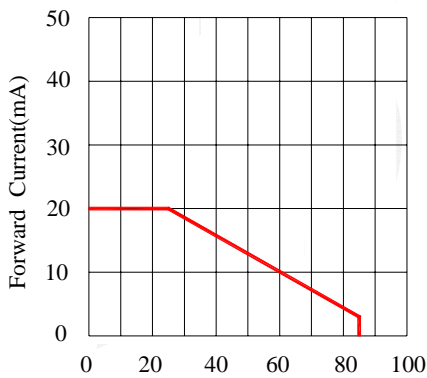

FORWARD CURRENT
DERATING CURVE

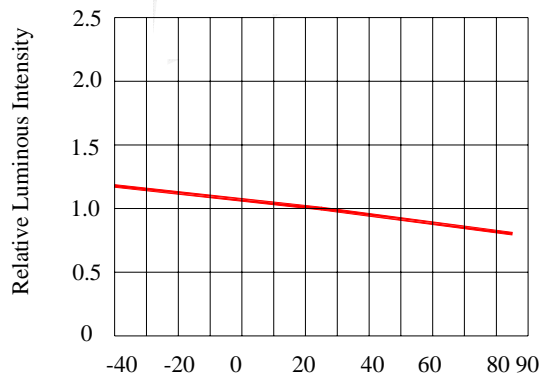

LUMINOUS INTENSITY Vs.
AMBIENT TEMPERATURE

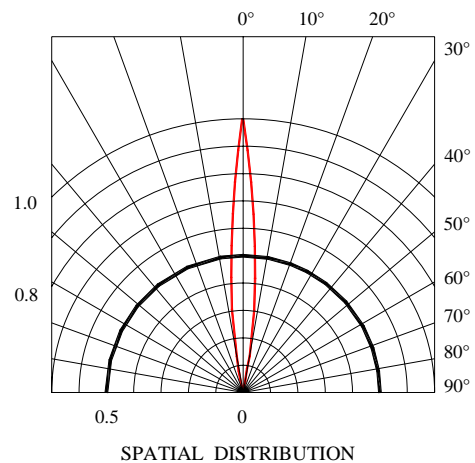
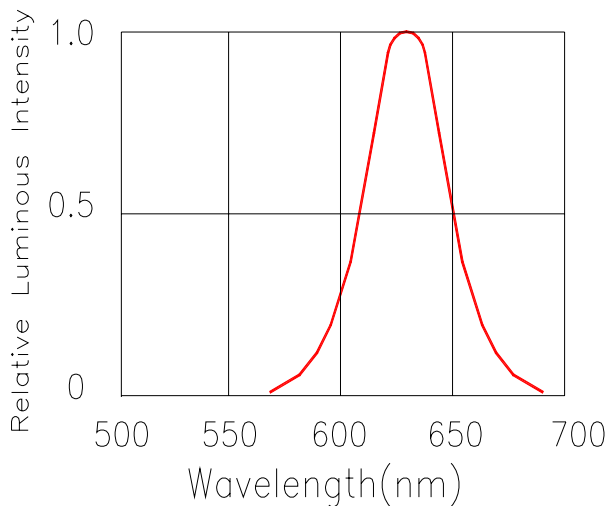

◆ Reliability Test Items and Conditions

Test Classification	Test Item	Test Conditions	Test Duration	Sample Size	AC/RE
Life Test	Room Temperature DC Operating Life Test	Ta=25°C±5°C, If=20mA	1000hrs	22pcs	0/1
Environment Test	Thermal Shock Test	100°C±5°C 5min ↓↑ -40°C±5°C 5min	20 cycles	22pcs	0/1
	Temperature Cycle Test	100°C±5°C 30min ↓↑5min -40°C±5°C 30min	20 cycles	22pcs	0/1
	High Temperature & High Humidity Test	85°C±5°C /85% RH	1000hrs	22pcs	0/1
	High Temperature Storage	Ta=100°C±5°C	1000hrs	22pcs	0/1
	Low temperature Storage	Ta=-40°C±5°C	1000hrs	22pcs	0/1
Mechanical Test	Resistance to Soldering Heat	Temp=260°C ±5°C T=5s max	5 times	22pcs	0/1

◆ Criteria for Judging the Damage

Item	Symbol	condition	Criteria for Judgement	
			MIN.	MAX.
Forward Voltage	VF (V)	IF=20mA	---	U.S.L*1.1
Reverse Current	IR (uA)	VR=5V	---	10uA
Luminous Intensity	IV (mcd)	IF=20mA	L.S.L*0.5	---

【Note】 1.USL: Upper Specification Level 2.LSL: Lower Specification Level

◆ CAUTIONS:

1. Lead Forming & Assembly

- Lead forming or bending must be done before soldering, at normal temperature.
- During lead forming, the leads should be bent at a point at least 3mm from the base of LED lens.
- Do not use the base of the lead frame as a fulcrum during lead forming.
- Avoid bending the leads at the same point more than once.
- During assembly on PCB, use minimum clinch force possible to avoid excessive mechanical stress.

2. LED Mounting Method

- The lead pitch of the LED must match the pitch of the mounting holes on the PCB during component placement. Lead-forming may be required to insure the lead pitch matches the hole pitch.
- When soldering wire to the LED. Use individual heat-shrink tubing to insulate the exposed leads to prevent accidental contact short-circuit.
- Use stand-offs or spacers to securely position the LED above the PCB.

3. Soldering

- When soldering, the soldering iron needs to be at least 3mm away from the epoxy edge. After soldering, allow at least 3 minutes for LEDs to cool back to normal temperature. DO not apply any pressure to the epoxy encapsulation or the lead frame during the soldering process.

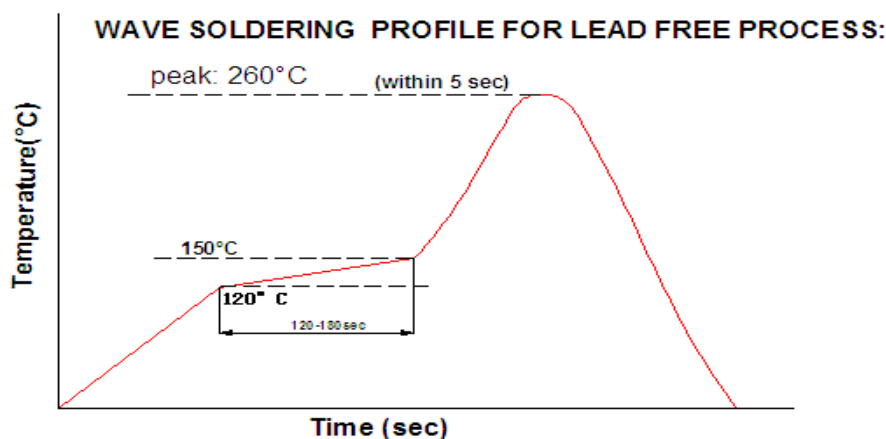

- When using soldering iron, please solder once for less than 5 seconds at a maximum temperature of 300°C. When soldering a row of LED on a PCB. Please do not solder both leads of a LED in sequence. (Solder all the positive lead first, then all the negative leads).
 - Do not dip the epoxy encapsulation part of LED into any soldering paste liquid.
 - After soldering, do not adjust the location of the LED anymore.
-

- When attaching electronic parts to a PCB with LEDs .the curing time for the whole PCB

Should be less than 60 seconds .at less than a temperature of 120°C.

4.Cleaning:

- Use alcohol-based cleaning solvents such as isopropyl alcohol to clean the LEDs if necessary.

5.Storage

- The storage ambient for the LEDs should not exceed 30°C temperature or 70% relative humidity.
- It is recommended that LEDs out of their original packaging are used within three months. For extended storage out of their original packaging, it is recommended that the LEDs be stored in a sealed container with appropriate desiccant or in desiccators with nitrogen ambient.

6.ESD (Electrostatic Discharge)

Static Electricity or power surge will damage the LED.

Suggestions to prevent of ESD damage.

- All devices, equipment, and machinery must be properly grounded.
- Use a conductive wrist band or anti-electrostatic glove when handling these LEDs.
- Maintain a humidity level of 50% or higher in production areas.
- Use anti-static packaging for transportation and storage.

7.Recommended Usage Guidelines

- Please only use 20mA(Lamp LED) of forward current to drive LEDs whether one LED or multiple LEDs are being used.
- Sudden surge could damage the LED interior connections.please design circuit with care to no sudden voltage surge or current surge will show when turning the circuit on or off.

◆ Revision History:

Rev. No.	Change description	Date	Prepared by	Checked by
A/0	New-made specification	2019.11.26	张萌	